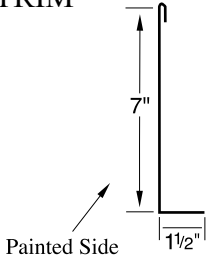
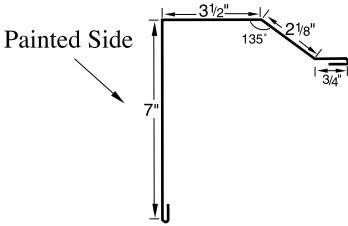
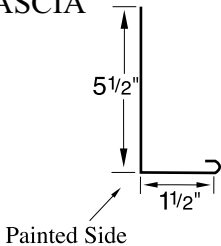
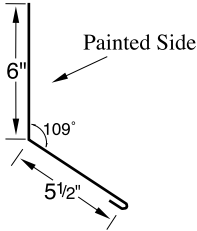

MICHIGAN CITY REGIONAL TRIMS

| | Part Number | Length |
|---|--------------------------------|----------------|
| <p>POST TRIM</p>  | SA(color)7 | 10'2" |
| <p>TRACK DOOR JAMB</p>  | TDJT10(color) TDJT16(color) | 10'2" 16'2" |
| <p>SOFFIT FASCIA</p>  | SAF(color)512 | 10'2" |
| <p>ENDWALL FLASHING</p>  | EFF(color) | 10'2" |

TRIMS

Part Number

Length

RIDGECAP

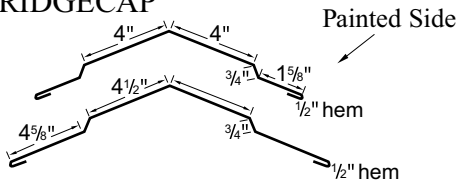

RCP(color)
RC2(color)

10'6" Recommended 6:12 or less
10'2" Recommended 7:12
or greater

RESIDENTIAL RIDGE CAP

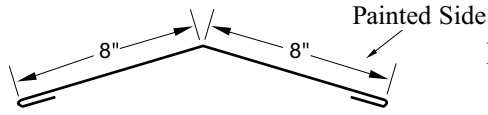

RRCP

10'2"

FORMED RIDGECAP

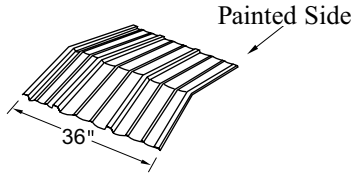

FRCP(color) Panel Loc
FRCP(color)+ Panel Loc Plus

3'

Specify pitch up to 4:12

RAKE & CORNER

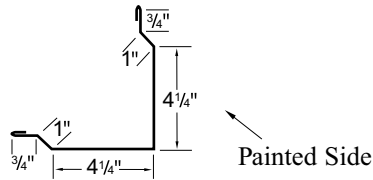

COR(color)10
COR(color)12
COR(color)14
COR(color)16
COR(color)18
COR(color)20

10'0"
12'0"
14'0"
16'0"
18'0"
20'0"

MINI CORNER

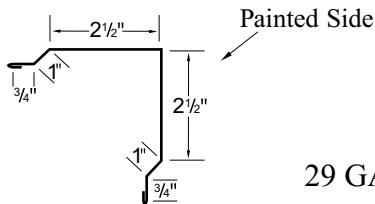

MCRN(color)10
MCRN(color)12
MCRN(color)14
MCRN(color)16

10'2"
12'2"
14'2"
16'2"

29 GAUGE LONG TRIM (Available in Michigan City plant only.)

MCRN9(color)12
MCRN9(color)14
MCRN9(color)16

12'2"
14'2"
16'2"

GABLE TRIM

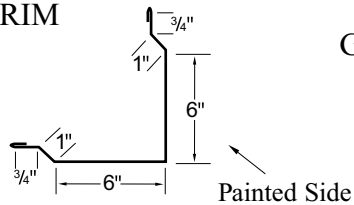

GT6(color)

10'2"

J-TRIM

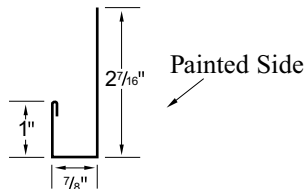

JT(color)

10'2"

TRIMS

Part Number

Length

RAT GUARD

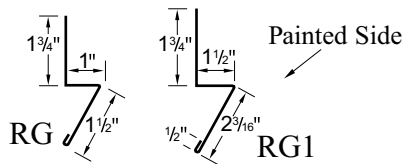

RG(color)
RG1(color)

10'2"
10'2"

VALLEY

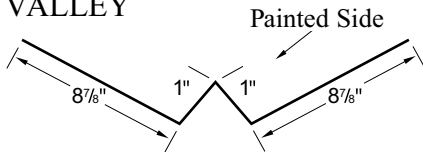

VT1(color)

10'2"

GAMBREL TRIM

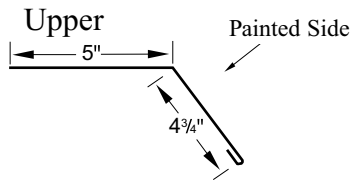

GTU(color)

10'2"
specify pitch

GAMBREL TRIM

Lower

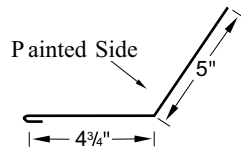

GTL(color)

10'2"
specify pitch

SINGLE ANGLE

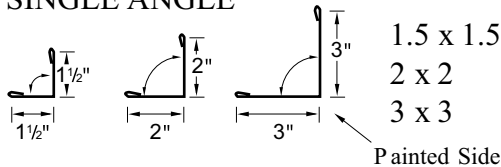

SA(color)112
SA(color)2X2
SA(color)3X3

10'2"
10'2"
10'2"

INSIDE ANGLE

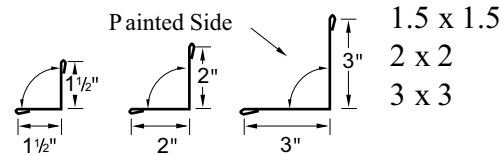

IA(color)112
IA(color)2X2
IA(color)3X3

10'2"
10'2"
10'2"

POST TRIM

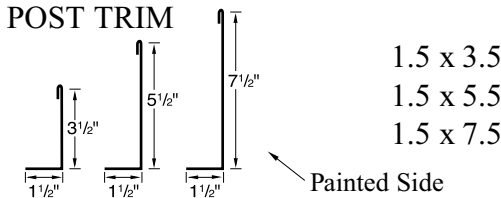

SA(color)312
SA(color)512
SA(color)712

10'2"
10'2"
10'2"

UNIVERSAL SIDEWALL

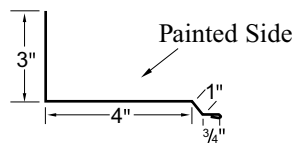

SF1(color)

10'2"

UNIVERSAL ENDWALL

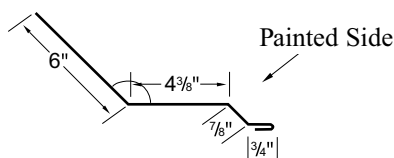

EF(color)

10'2"
specify pitch

TRIMS

Part Number

Length

SQUARE BASE

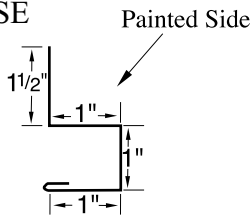

SBA(color)

10'2"

OVERHEAD DOOR JAMB

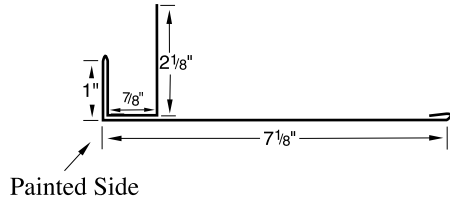

OHDJ(color)
OHDJ12(color)
OHDJ14(color)
OHDJ16(color)

10'2"
12'2"
14'2"
16'2"

OVERHEAD DOOR JAMB 9 1/4"

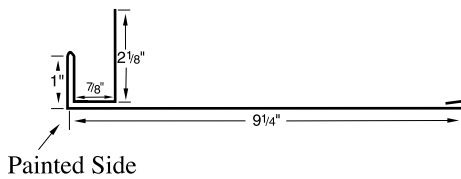

OHDJ9(color)
OHDJ916(color)

10'2"
16'2"*

*Offered out of Michigan city location. Longer lead times may apply.

SOFFIT F&J

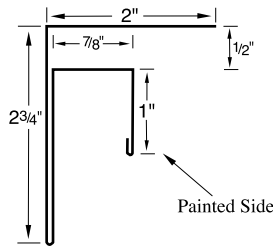

SFJ(color)

10'2"

PANEL LOC PLUS F&J

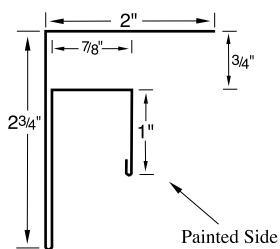

PFJ(color)

10'2"

PEAK PLATE

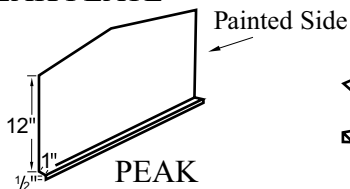

PEAK(color)
LRPBOXF

3'

LRPBOXF

Standard 4:12

RESIDENTIAL RAKE

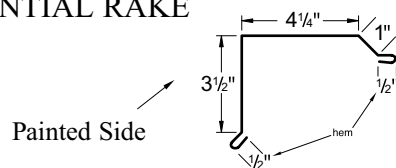

RRT(color)

10'2"

TRIMS

Part Number

Length

DOOR EDGE

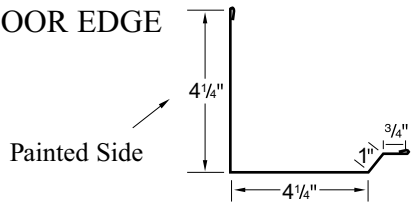

DJ10(color)

10'2"

INSIDE CORNER

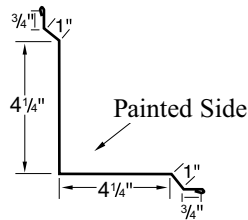

IC1(color)

10'2"

DOUBLE ANGLE

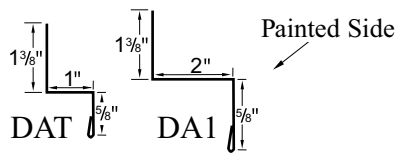

DAT(color)

10'2"

DA1(color)

10'2"

ROUND TRACK COVER

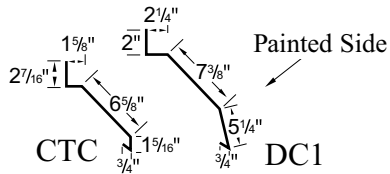

CTC(color)

10'2"

DC1(color)

10'2"

SQUARE TRACK COVER

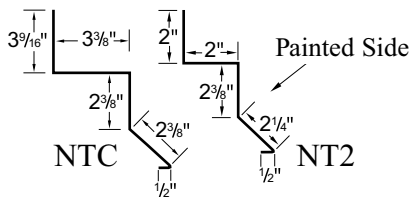

NTC(color)*

10'2"

NT2(color)*

10'2"

*hardware not available

FASCIA

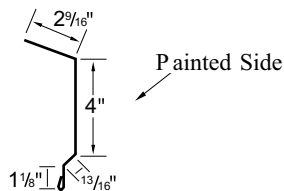

FT(color)

10'2"

specify pitch

RESIDENTIAL EAVE TRIM

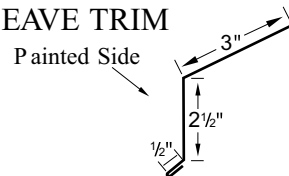

RET(color)

10'2"

specify pitch

GABLE BASE SOFFITT

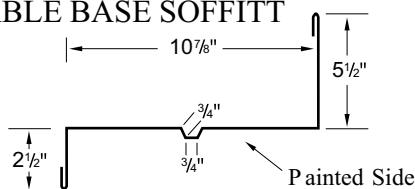

GB1(color)

10'2"

TRIMS

Part Number

Length

WINDOW DRIP CAP

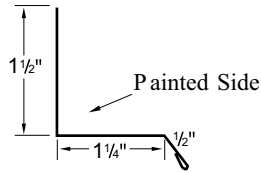

WC(color)

10'2"

DRIP EDGE

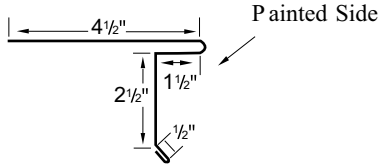

RDC(color)

10'2"

Default is 90°
as shown
Specify pitch
6:12 or less

DOOR POST TRIM

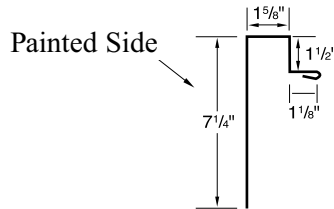

DJ8(color)

10'2"

FLAT SHEETS*

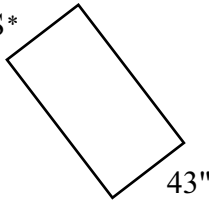

(color)CQ

10'2"

*There will be an additional
pallet charge for flat sheets

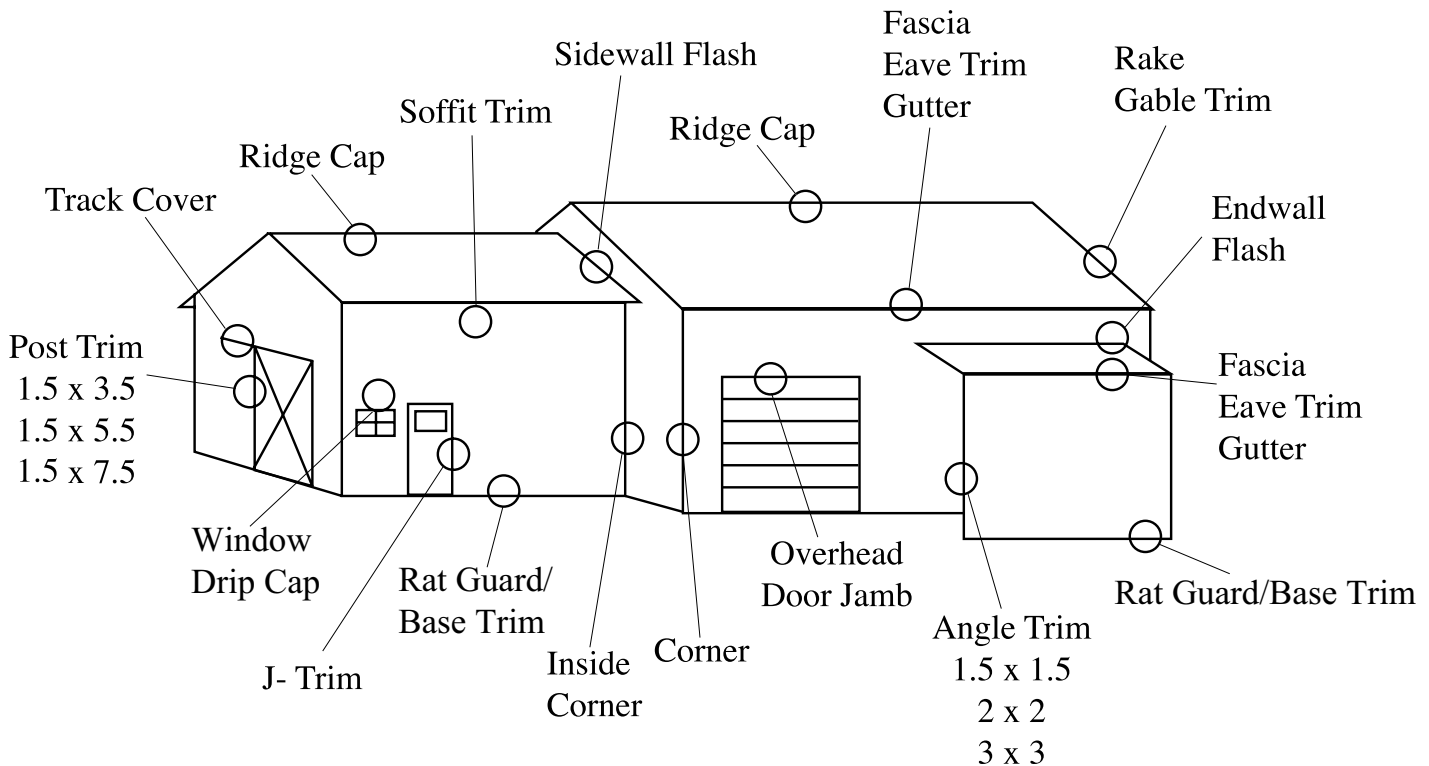

SOFFIT

Part Number

Length

F&J ASSEMBLY
(SFA & JT)

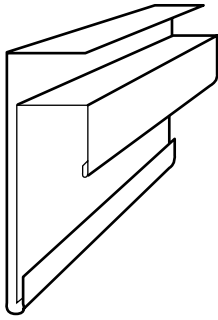

SOFFIT
F ADAPTOR

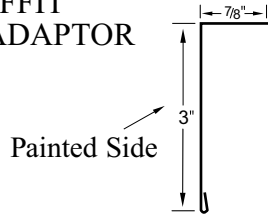

SFA

10'2"

J-TRIM

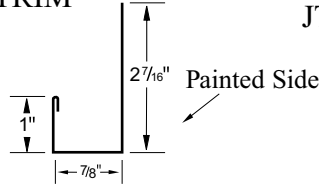

JT(color)

10'2"

SOFFIT J-TRIM

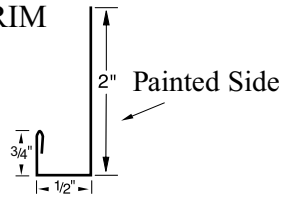

SJT(color)

10'2"

ALUMINUM SOFFIT

Vented (VS) or Solid (SS)

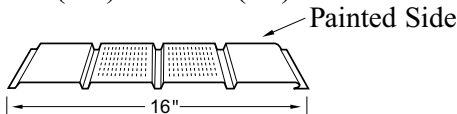

VS(color)12

12'2"

SS(color)12

12'2"

BEADED FASCIA

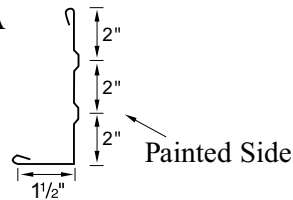

BFT(color)

10'2"

F CHANNEL *

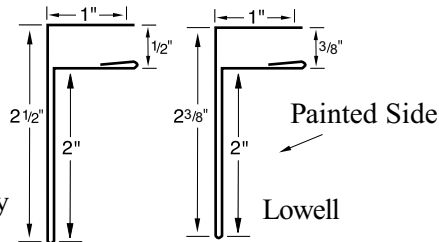

FC(color)

10'2"

Michigan City

Lowell

*Varies by plant location; please call your salesperson to verify availability.

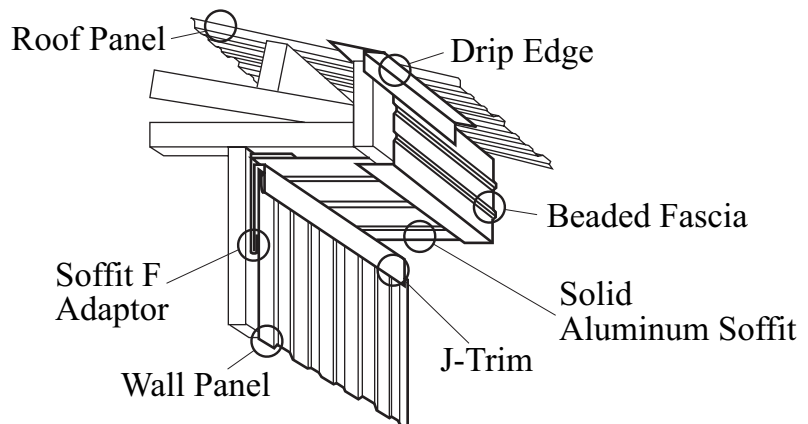
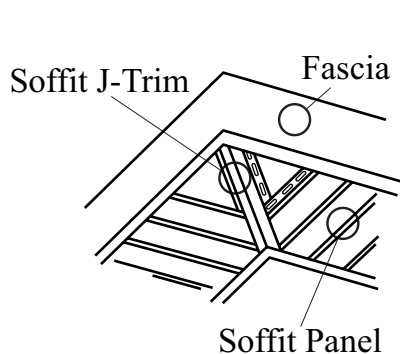

GUTTERS

(Gutters not available in Gold, Bare Metal, Hawaiian Blue or Polar White)

Part Number

Length

GUTTER

K5G206(color)

20'6"

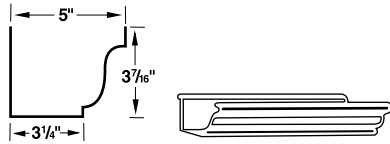

GUTTER END CAP

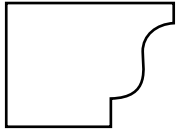

Left hand shown

K5GEQR(color)

K5GECL(color)

Right

Left

Specify right or left hand

CORNER BOXES

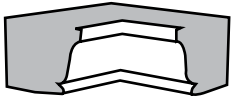

Inside

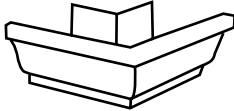

Outside

K5GISQCR Inside

K5GOSQCR Outside

White Only

CONCEALED FASCIA BRACKET

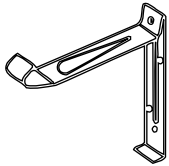

K5GCFZ

sold separately or
Qty: 100 per box

SPIKES & FERRULES

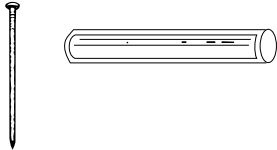

K5GS8

8" Spike

sold separately or
Qty: 50 lbs. per box

K5GF5

5" Ferrule

sold separately or
Qty: 500 per box

DOWNPOUT

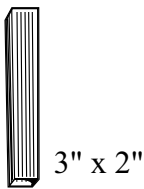

3" x 2"

K5GDS10(color)

10'0"

sold separately or
Qty: 15 per box

DOWNPOUT STRAP



K5GSCB(color)

sold separately or
Qty: 100 per box

DOWNPOUT ELBOW

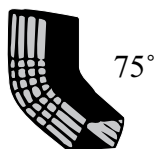

75°

K5GEA(color)

sold separately or
Qty: 20 per box

OVAL OUTLET

w/ Flange

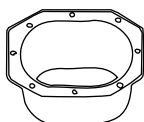

K5GOOFZ

sold separately or
Qty: 20 per box

K5 Gutter

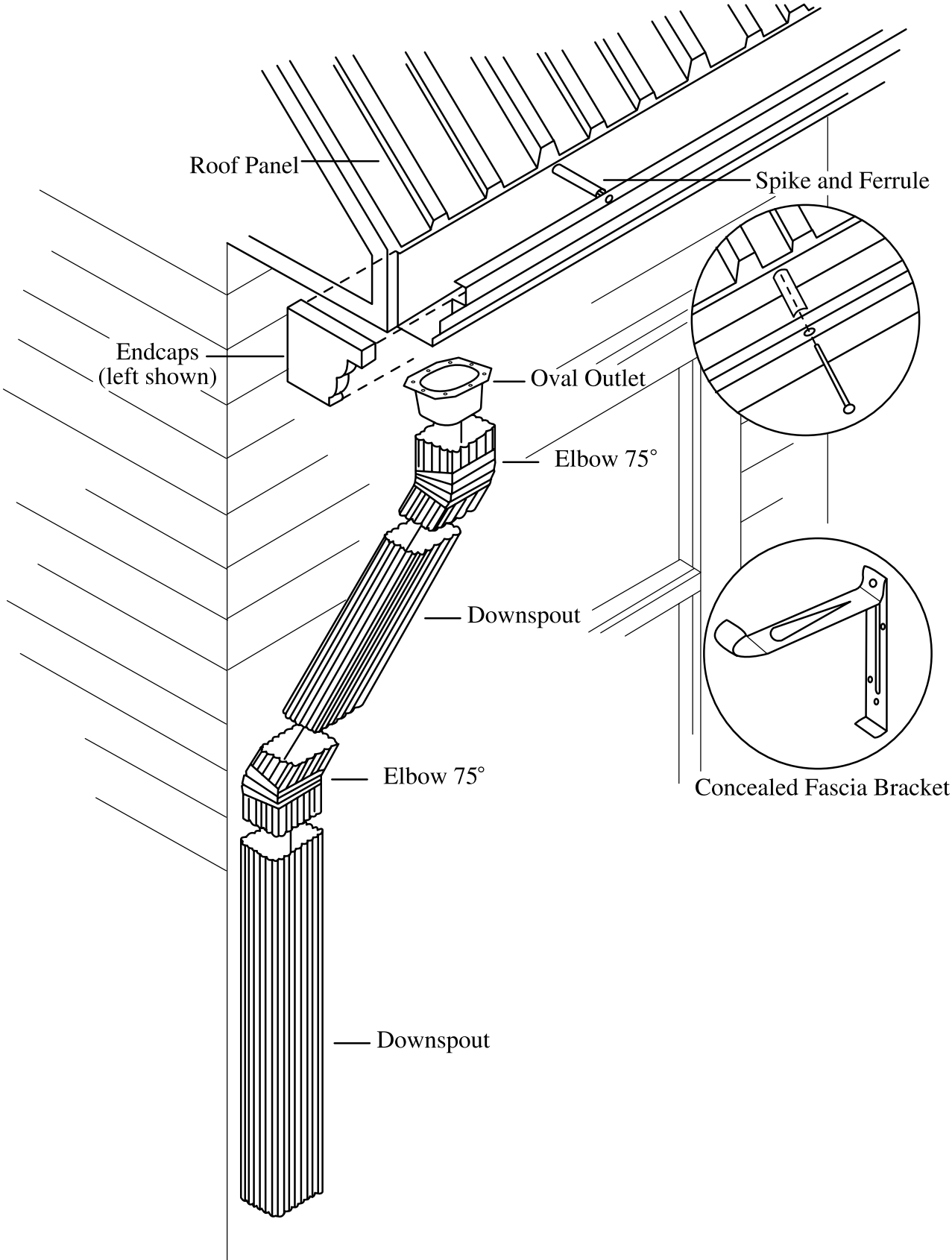

ACCESSORIES

| | Part Number | Color | Length | SqFt Weight |
|--|-------------|-------|--------|-------------|
|--|-------------|-------|--------|-------------|

FIBERGLASS SKYLIGHTS

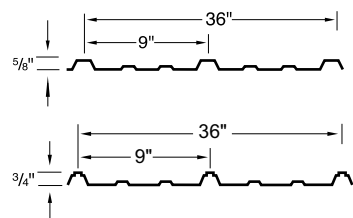

| | | | |
|-----------|-------|-----|-----|
| SKY8 (+) | White | 8' | 5oz |
| SKY10 (+) | White | 10' | 5oz |
| SKY12 (+) | White | 12' | 5oz |

POLYCARBONATE SKYLIGHTS

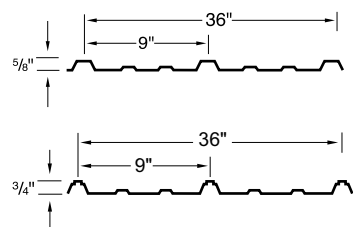

| | |
|---------------|----------------------------------|
| SKYPCW8 (+)* | SKYPCC8 + (Panel Loc Plus Only) |
| SKYPCW10 (+)* | SKYPCC10 + (Panel Loc Plus Only) |
| SKYPCW12(+)* | SKYPCC12 + (Panel Loc Plus Only) |

CONTINUOUS RIDGE VENT

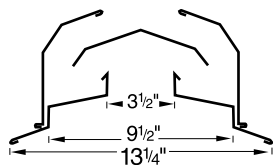

| | | |
|-----|-------|-----|
| RLW | White | 10' |
|-----|-------|-----|

CLOSURE VENT

Closure is 1 3/8" tall, may require longer screw for installation.



| | | |
|--------------------------------|----|---|
| CLV+ (Panel Loc Plus) | 3' | Available at Jasper, Cedar Hill and Michigan City |
| CLV+M (Panel Loc Plus) (Marco) | 3' | Available at Lowell |

Item may vary from sample shown. Contact sales rep for more information Qty: 50 per box

MASTER PIPE FLASHING

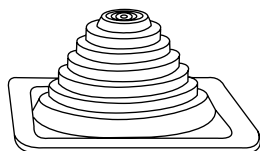

| Part Number | Size | |
|-------------|--------------|---------------------|
| MPF | 1/4" to 4" | |
| MPF2 | 1 1/4" to 3" | |
| MPF4 | 3" to 6" | |
| MPF6 | 5" to 9" | |
| MPF7 | 6" to 11" | Maximum temperature |
| MPF8 | 7" to 13" | 250 degrees |
| 4SMPF* | 3" to 6" | |
| 6SMPF* | 5" to 9" | |
| 8SMPF* | 7" to 13" | Maximum temperature |
| 10SMPF* | 13" to 26" | 500 degrees |

MASTER PIPE FLASHING WITH ZIPPER

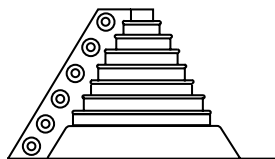



| | |
|----------|-------------------------|
| MPF1ZIP* | 1/2" - 4" with zipper |
| MPF2ZIP* | 4 1/2" - 9" with zipper |

*Not available in all locations. Contact sales rep for lead times.

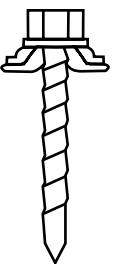
ACCESSORIES

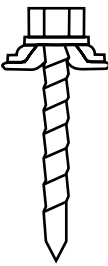
| | Part Number | Length | Color | # per Bag | # per Box |
|---|--------------------|---------------|-----------------|------------------|------------------|
| METAL/WOOD SCREWS #10 | | | | | |
|  1/4" head | 1(color)MW | 1" | All | 250pc | 3000pc |
| | 1 1/2(color)MW | 1 1/2" | All | 250pc | 2500pc |
| | 2(color)MW | 2" | All | 250pc | 2000pc |
| | 2 1/2(color)MW | 2 1/2" | All except gold | 250pc | 1500pc |
| | 3(color)MW | 3" | All except gold | 250pc | 1000pc |
| Per bag or per box quantities only Minimum quantity 1 bag | | | | | |

| | Part Number | Length | Color | # per Bag | # per Box |
|--|--------------------|---------------|--------------|------------------|------------------|
| STITCH SCREWS | | | | | |
|  1/4" head | 34(color)ST | 3/4" | All | 250pc | 3000pc |
| Per bag or per box quantities only Minimum quantity 1 bag | | | | | |

| | | | | | |
|--|--------------|--------|---|-------|--------|
| METAL/ METAL SCREW #12 | | | | | |
|  5/16" head | 34(color)MM | 3/4" | All | 250pc | 2500pc |
| | 114(color)MM | 1 1/4" | All | 250pc | 2500pc |
| | 112(color)MM | 1 1/2" | White, Brilliant, Stone, Bare, Green | 250pc | 2500pc |
| Per bag or per box quantities only Minimum quantity 1 bag | | | | | |

| | | | | | |
|--|--------------|------|-----|-------|--------|
| LAP SCREWS | | | | | |
|  5/16" head | 78(color)LAP | 7/8" | All | 250pc | 2500pc |
| Per bag or per box quantities only Minimum quantity 1 bag | | | | | |

ACCESSORIES

Part Number

Length

CLOSURES

(INSIDE or OUTSIDE)

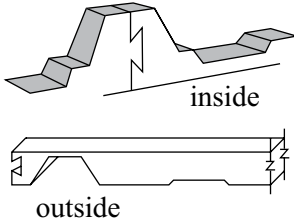

| | | |
|------------|--|----|
| CLOUT | Panel Loc outside (no adhesive) | 3' |
| CLOUT+ | Panel Loc Plus outside(no adhesive) | 3' |
| CLIN | Panel Loc inside (no adhesive) | 3' |
| CLIN+ | Panel Loc Plus inside (no adhesive) | 3' |
| CLOUTWGLUE | Panel Loc outside (with adhesive) | 3' |
| CLOUT+GLUE | Panel Loc Plus outside (with adhesive) | 3' |
| CLINWGLUE | Panel Loc inside (with adhesive) | 3' |
| CLIN+GLUE | Panel Loc Plus inside (with adhesive) | 3' |

100 per box

Part Number

Length

Size

UNIVERSAL POLYFOAM

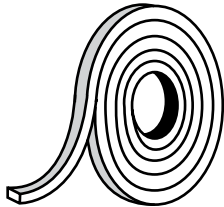

| | | |
|------|-----|------------------|
| POLY | 25' | 1"x1 1/2" |
| | | 20 rolls per bag |

Part Number

Length

Width

Thickness

GRAYFLEX Joint Seal Tape



| | | | |
|------------|-----|------------------|-----------------|
| GRAYFLEX-6 | 20' | 1" | 1" ** |
| | | 10 rolls per box | **Expanded size |

Part Number

Length

Width

Thickness

BUTYL TAPE

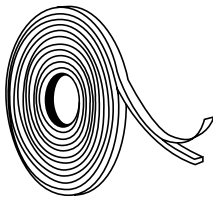

| | | | |
|-----|-----|------|-------|
| BT | 40' | 1/4" | 3/16" |
| BTR | 40' | 7/8" | 3/16" |

BT 20 rolls per box
BTR 10 rolls per box

Part Number

Length

VERSAVENT



| | |
|-------|-----|
| VERSA | 10' |
|-------|-----|

ACCESSORIES

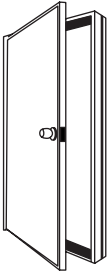
| | Part Number | Size | Overall Dimension |
|---|-------------------|------|----------------------|
| DOORS with lock set  | DR (99 Series)* | 3068 | 37 9/16" x 81 13/16" |
| | DR4 (99 Series)* | 4068 | 49 9/16" x 81 13/16" |
| | 66DR (66 Series)* | 3068 | 37 1/4" x 81 1/4" |
| | 88DR (88 Series)* | 3068 | 40" x 81 13/16" |

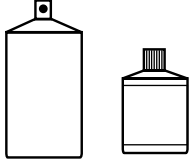
| | | |
|---|--------------------------------|--|
| TOUCH UP PAINT  | 4(color)SP 4ZZSP 12PURSP | 0.6oz bottle with brush 4.5oz spray can (backer paint) 12oz spray can (purlin paint) |
|---|--------------------------------|--|

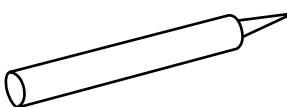
| | | |
|--|--------------------|--|
| GEOCEL-TRIPOLYMER SEALANT  | GEO(color)* | 10.6 oz. tube clear, gray, white Qty: 24 per box |
| | Part Number | Size |

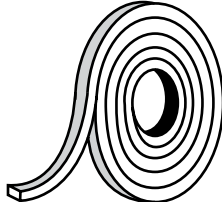

| | | |
|---|-----------|-------------|
| RETRO-EASE  | RETROEASE | 300ft. roll |
|---|-----------|-------------|

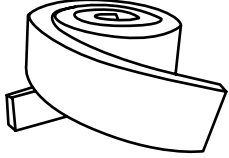
| | | | | |
|--|-----------------------------------|--------------------------------|--------------|------------------|
| WINDOWS  | slider w/ screen non-insulated | WD3X3* 3x3 WD3X2* 3x2 | | |
| | Part Number | Length | Width | Thickness |

| | | | | |
|--|-----------|--------------------------|----|--------|
| FLEXOVENT  | FLEXOVENT | 10' | 3" | 1 1/2" |
| | | Qty: 2 10' rolls per box | | |

* Longer lead times in Michigan City. Contact sales person for details.

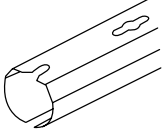
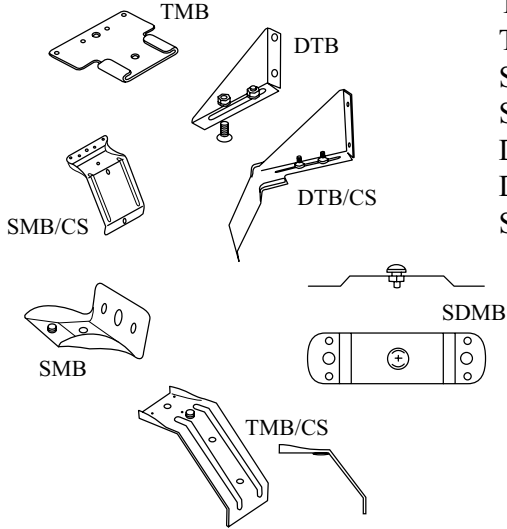
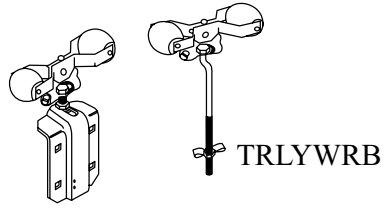
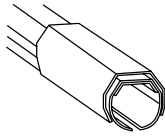
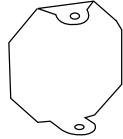
SLIDING DOORS

| | Part Number | Length |
|---|-------------|---|
| SLOTTED TRACK | | |
|  | 8STRK | 8' |
| | 10STRK | 10' |
| | 12STRK | 12' |
| TRACK MOUNTING BRACKETS | | |
|  | TMB | Top Mount Bracket |
| | TMB/CS | Top Mount Bracket w/Cover Support |
| | SMB | Side Mount Bracket |
| | SMB/CS | Side Mount Bracket w/ Cover Support |
| | DTB | Double Track Bracket |
| | DTB/CS | Double Track Bracket w/Cover Support |
| | SDMB | Stud Mount Bracket |
| | | |
| TROLLEYS | | |
|  | DSRLLRWRB | Plate Trolley w/ Roller Bearing (includes endcaps) |
| | TRLYWRB | 9.5" Bolt w/ Roller Bearing |
| DSRLLRWRB | | Qty: 2 per bag |
| SPLICE CLIP | | |
|  | SPLCLP | |
| TRACK END CAP | | |
|  | ENDCAP | |
| DOOR PULL | | |
| White | DRPUL | Available in white only |
|  | | |

NOTE: Illustrations may not match actual parts. Contact salesperson for details.

SLIDING DOORS

Part Number

DOOR STOPS

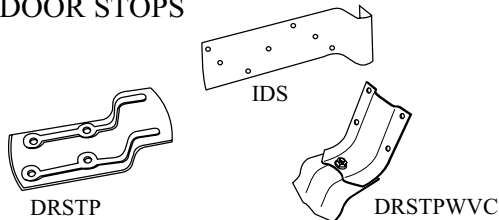

IDS Inside Door Stop
 DRSTP Heavy Duty Stop
 DRSTPWVC Adjustable Stop

DOOR LOCKS

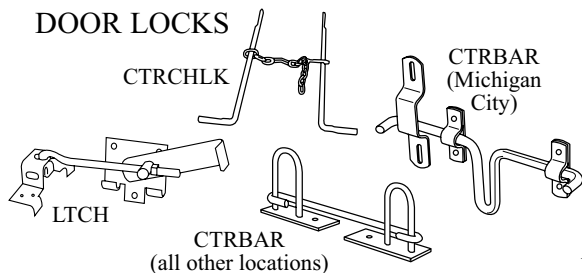

LTCH Jamb Latch (Cam Latch)
 CTRCHLK Center Chain Lock
 CTRBAR Center Bar Lock

NOTE: Illustrations may not match actual parts. Contact salesperson for details.

ALUMINUM VERTICAL RAILS

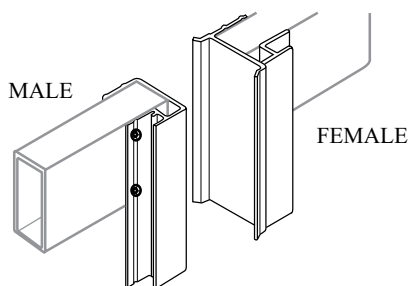

| Part Number | Length |
|-------------|--------------|
| 10VRTRL | 10'AV Male |
| 12VRTRL | 12'AV Male |
| 14VRTRL | 14'AV Male |
| 16VRTRL | 16'AV Male |
| 10VRTWH | 10'HV Female |
| 12VRTWH | 12'HV Female |
| 14VRTWH | 14'HV Female |
| 16VRTWH | 16'HV Female |

CENTER DOOR GUIDE *

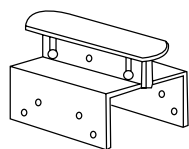

CGWHD

ALUMINUM BOTTOM RAIL FOR GUIDE*

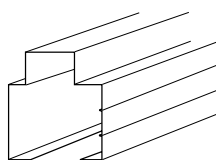

| Part Number | Length |
|-------------|--------|
| 8BRL | 8' |
| 10BRL | 10' |
| 12BRL | 12' |
| 14BRL | 14' |
| 16BRL | 16' |

BOTTOM GUIDE RAIL*

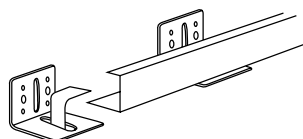

| | |
|--------|-----|
| 6BGRL | 6' |
| 8BGRL | 8' |
| 10BGRL | 10' |

*These 3 components are designed to go together as a guide system.

SLIDING DOORS

Part Number

HEAVY DUTY
STAY ROLLER⁺⁺

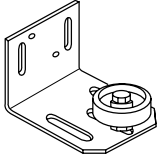

STYRLLR

Part Number

Length

ALUMINUM BOTTOM RAIL
FOR STAYROLLER⁺⁺

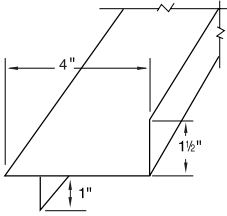

ABRL12

12'

⁺⁺ These 2 components are designed to go together as a guide system.

SLIDING DOORS

- 1) Slotted Track
- 2) End Cap
- 3) Track Mount Bracket for Track & Cover
- 4) Trolley
- 5) Splice Clip
- 6) Door Pull
- 7) Stay Roller
- 8) Door Stop

