

# Horizon -Loc

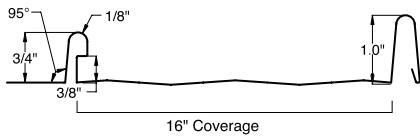

Horizon-Loc is available in 26ga AZ50 painted Galvalume and bare Galvalume. Central States uses either the CentralGuard™ or Kynar 500®/Hylar 5000® paint system on all painted metals. Bare (non-painted) metals from Central States will have an acrylic coating. This acrylic coating helps protect the metal during manufacturing and installation. This clear organic treatment applied over the Galvalume coating is invisible, but provides enhanced performance applicability and retained heat reflectivity. There is no need for oils to be applied during forming. This organic treatment eliminates fingerprinting and foot marking during installation.

Central States' 26ga steel is manufactured to meet ASTM A792 specifications for Galvalume and ASTM A653 for galvanized with a minimum yield of 50,000 PSI. Horizon-Loc also has UL2218/Class 4 Impact Resistance Rating and UL790 Fire Resistance. A minimum roof slope for the 3/4" tall Horizon-Loc is 3:12. The minimum pitch will allow for sufficient drainage of water. No load table available. Install Horizon-Loc over a solid decking with 30 lb. felt paper or equivalent.

**NOTE: Oil canning in the flat area of the panels is common to the industry and does not affect the integrity of the panel. Therefore, oil canning is not a reason for rejection.**

## HORIZON-LOC EXPOSED FASTENER TRIMS 26 ga. only

### HORIZON-LOC EAVE TRIM

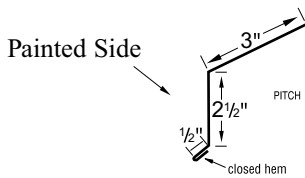

### Part Number Length

HLRE102(color)	10'2"	
HLRE122(color)	12'2"	
HLRE142(color)	14'2"	
HLRE162(color)	16'2"	
HLRE182(color)	18'2"	Specify pitch.
HLRE204(color)	20'4"	

### HORIZON-LOC HIGH SIDE EAVE TRIM

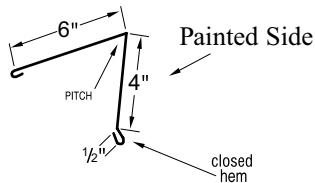

HLHS102(color)	10'2"	
HLHS122(color)	12'2"	
HLHS142(color)	14'2"	
HLHS162(color)	16'2"	
HLHS182(color)	18'2"	Specify pitch.
HLHS204(color)	20'4"	

### HORIZON-LOC PANEL CAP

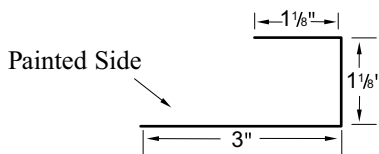

HLPC102(color)	10'2"
HLPC122(color)	12'2"
HLPC142(color)	14'2"
HLPC162(color)	16'2"
HLPC182(color)	18'2"
HLPC204(color)	20'4"

### HORIZON-LOC ZEE CLOSURE

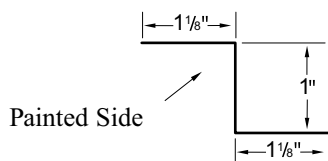

HLZC102(color)	10'2"
----------------	-------

Butyl tape needed with this product.

### HORIZON-LOC START/FINISH TRIM

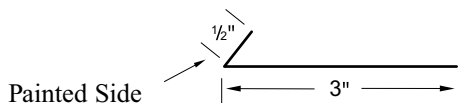

HLSF102(color)	10'2"
----------------	-------

# HORIZON-LOC EXPOSED FASTENER TRIMS

26 ga. only

## HORIZON-LOC WIDE VALLEY TRIM

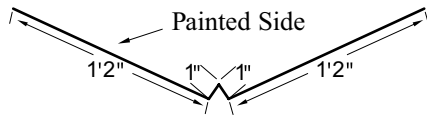

### Part Number

### Length

HLWVT102(color)	10'2"
HLWVT122(color)	12'2"
HLWVT142(color)	14'2"
HLWVT162(color)	16'2"
HLWVT182(color)	18'2"
HLWVT204(color)	20'4"

Specify pitch.

## HORIZON-LOC VALLEY

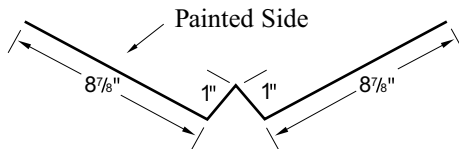

HLVT102(color)	10'2"
HLVT122(color)	12'2"
HLVT142(color)	14'2"
HLVT162(color)	16'2"
HLVT182(color)	18'2"
HLVT204(color)	20'4"

Specify pitch.

## HORIZON-LOC RAKE TRIM

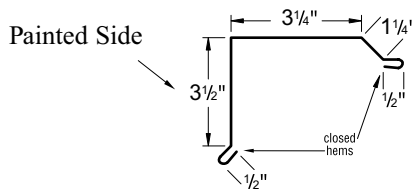

HLRRT102(color)	10'2"
HLRRT122(color)	12'2"
HLRRT142(color)	14'2"
HLRRT162(color)	16'2"
HLRRT182(color)	18'2"
HLRRT204(color)	20'4"

## HORIZON-LOC J-TRIM

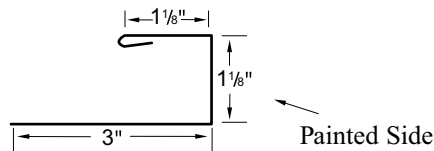

HLJT102(color)	10'2"
HLJT122(color)	12'2"
HLJT142(color)	14'2"
HLJT162(color)	16'2"
HLJT182(color)	18'2"
HLJT204(color)	20'4"

## HORIZON-LOC RIDGE CAP

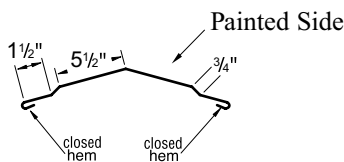

HLRH102(color)	10'2"
HLRH122(color)	12'2"
HLRH142(color)	14'2"
HLRH162(color)	16'2"
HLRH182(color)	18'2"
HLRH204(color)	20'4"

Specify pitch.  
Recommend  
6/12 or less.

## HORIZON-LOC RESIDENTIAL RIDGECAP

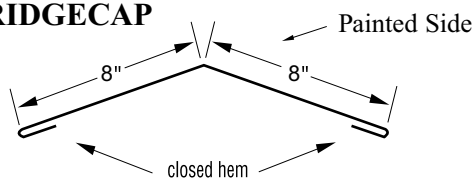

RRCP102(color)	10'2"
RRCP122(color)	12'2"
RRCP142(color)	14'2"
RRCP162(color)	16'2"
RRCP182(color)	18'2"
RRCP204(color)	20'4"

Specify pitch.

## HORIZON-LOC HIP CAP

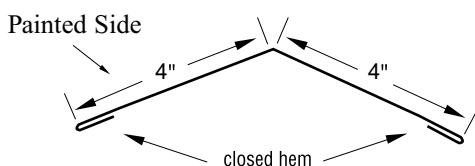

HIP102(color)	10'2"
HIP122(color)	12'2"
HIP142(color)	14'2"
HIP162(color)	16'2"
HIP182(color)	18'2"
HIP204(color)	20'4"

Specify pitch.

# HORIZON-LOC EXPOSED FASTENER TRIMS

26 ga. only

## HORIZON-LOC DRIP EDGE

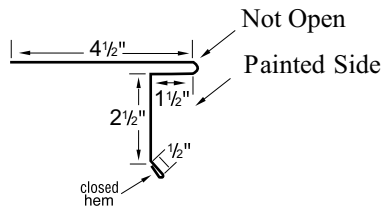

### Part Number

### Length

HLRDC102(color)	10'2"
HLRDC122(color)	12'2"
HLRDC142(color)	14'2"
HLRDC162(color)	16'2"
HLRDC182(color)	18'2"
HLRDC204(color)	20'4"

Specify pitch.

## HORIZON-LOC SIDEWALL TIE-IN

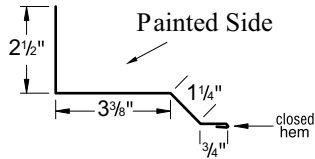

HLSW102(color)	10'2"
HLSW122(color)	12'2"
HLSW142(color)	14'2"
HLSW162(color)	16'2"
HLSW182(color)	18'2"
HLSW204(color)	20'4"

## HORIZON-LOC ENDWALL TIE-IN

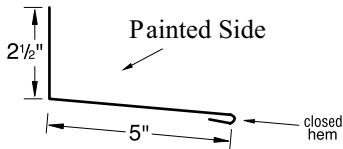

HLEW102(color)	10'2"
HLEW122(color)	12'2"
HLEW142(color)	14'2"
HLEW162(color)	16'2"
HLEW182(color)	18'2"
HLEW204(color)	20'4"

Specify pitch.

## HORIZON-LOC DRIP EDGE

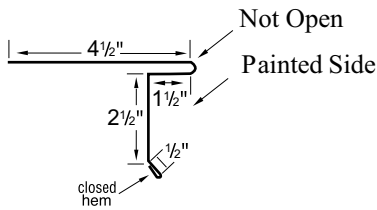

### Part Number

### Length

HLRDC102(color)	10'2"
HLRDC122(color)	12'2"
HLRDC142(color)	14'2" Specify pitch.
HLRDC162(color)	16'2"
HLRDC182(color)	18'2"
HLRDC204(color)	20'4"

## OPEN HEM RAKE

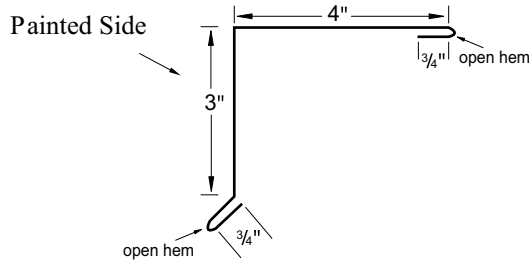

CFRA102(color)	10'2"
CFRA122(color)	12'2"
CFRA142(color)	14'2"
CFRA162(color)	16'2" Zee & Cleat needed.
CFRA182(color)	18'2"
CFRA204(color)	20'4"

## HORIZON-LOC CLEAT

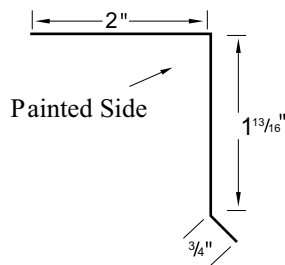

HLCL102(color)	10'2"
----------------	-------

## OPEN HEM SIDEWALL/ENDWALL

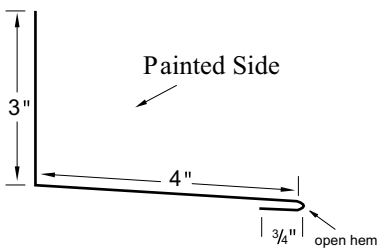

CFSI102(color)	10'2"
CFSI122(color)	12'2"
CFSI142(color)	14'2"
CFSI162(color)	16'2" Specify pitch.
CFSI182(color)	18'2" Zee needed.
CFSI204(color)	20'4"

## HORIZON-LOC ZEE CLOSURE

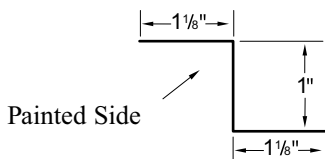

HLZC102(color)	10'2"
----------------	-------

Butyl tape needed.

## OPEN HEM RIDGE CAP

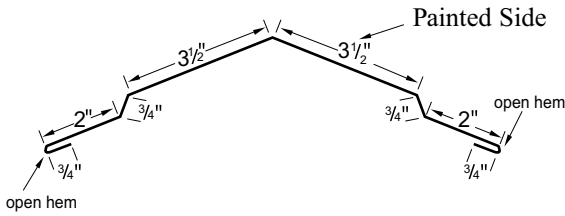

Part Number	Length
CFRC102(color)	10'2"
CFRC122(color)	12'2"
CFRC142(color)	14'2"
CFRC162(color)	16'2"
CFRC182(color)	18'2"
CFRC204(color)	20'4"

Specify pitch (recommended 6:12 or less.)  
Zee needed.

## OPEN HEM VALLEY

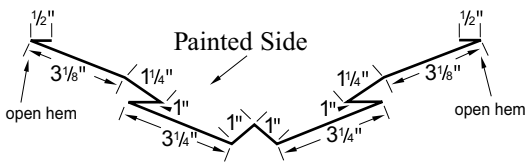

CFVT102(color)	10'2"
----------------	-------

Specify pitch.

## OPEN HEM GAMBREL

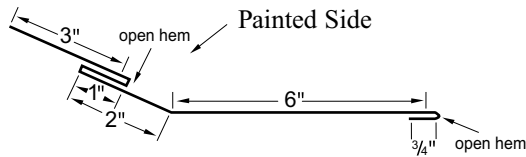

CFGA102(color)	10'2"
CFGA122(color)	12'2"
CFGA142(color)	14'2"
CFGA162(color)	16'2"
CFGA182(color)	18'2"
CFGA204(color)	20'4"

Specify pitch.  
Zee needed.

## OPEN HEM FLAT RIDGE

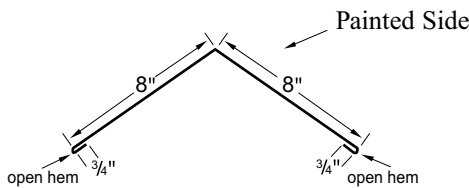

CFFRC102(color)	10'2"
CFFRC122(color)	12'2"
CFFRC142(color)	14'2"
CFFRC162(color)	16'2"
CFFRC182(color)	18'2"
CFFRC204(color)	20'4"

Specify pitch.  
Zee needed.

## OPEN HEM WIDE RIDGE CAP

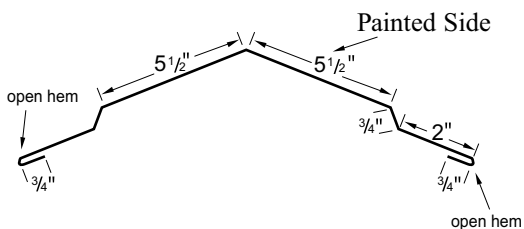

CFWRC102(color)	10'2"
CFWRC122(color)	12'2"
CFWRC142(color)	14'2"
CFWRC162(color)	16'2"
CFWRC182(color)	18'2"
CFWRC204(color)	20'4"

Specify pitch (recommended 7:12 or greater.)  
Zee needed.

# LOW RIB TRIMS

29 ga. only

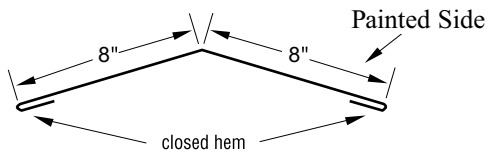
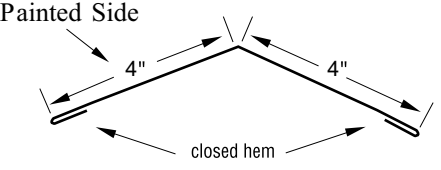
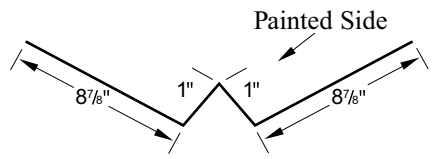
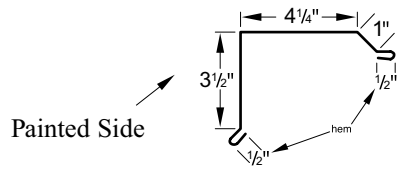
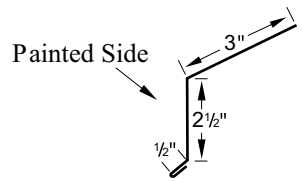
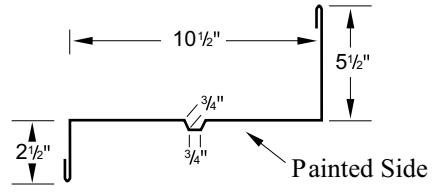
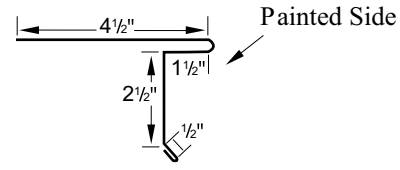
	Part Number	Length	
<b>RESIDENTIAL RIDGECAP</b> 	RRCP(color)	10'2"	Specify pitch.
<b>HIP CAP</b> 	HIP(color)	10'2"	Specify pitch.
<b>VALLEY</b> 	VT1(color)	10'2"	Specify pitch.
<b>RESIDENTIAL RAKE TRIM</b> 	RRT(color)	10'2"	
<b>RESIDENTIAL EAVE TRIM</b> 	RET(color)	10'2"	Specify pitch.
<b>GABLE BASE SOFFIT</b> 	GB1(color)	10'2"	
<b>RESIDENTIAL DRIP EDGE</b> 	RDC(color)	10'2"	Specify pitch. (6/12 maximum) Default is 90° as shown.

# LOW RIB TRIMS

## RIDGECAP (RCP)

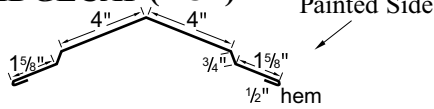

## WIDE RIDGECAP (RC2)

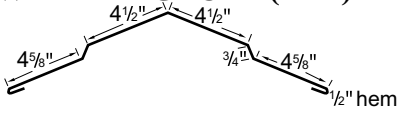

## Part Number

## Length

RCP(color)

10'6"

Specify pitch

RC2(color)

10'2"

## MINI CORNER

26 GAUGE ONLY

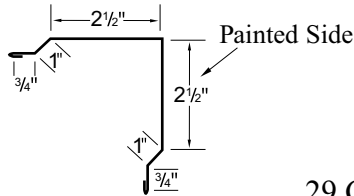

MCRN(color)10

10'2"

MCRN(color)12

12'2"

MCRN(color)14

14'2"

MCRN(color)16

16'2"

29 GAUGE LONG TRIM (Available in Michigan City plant only.)

MCRN9(color)12

12'2"

MCRN9(color)14

14'2"

MCRN9(color)16

16'2"

## GAMBREL TRIM

Lower

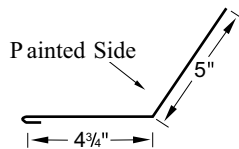

GTL(color)

10'2"

Specify pitch

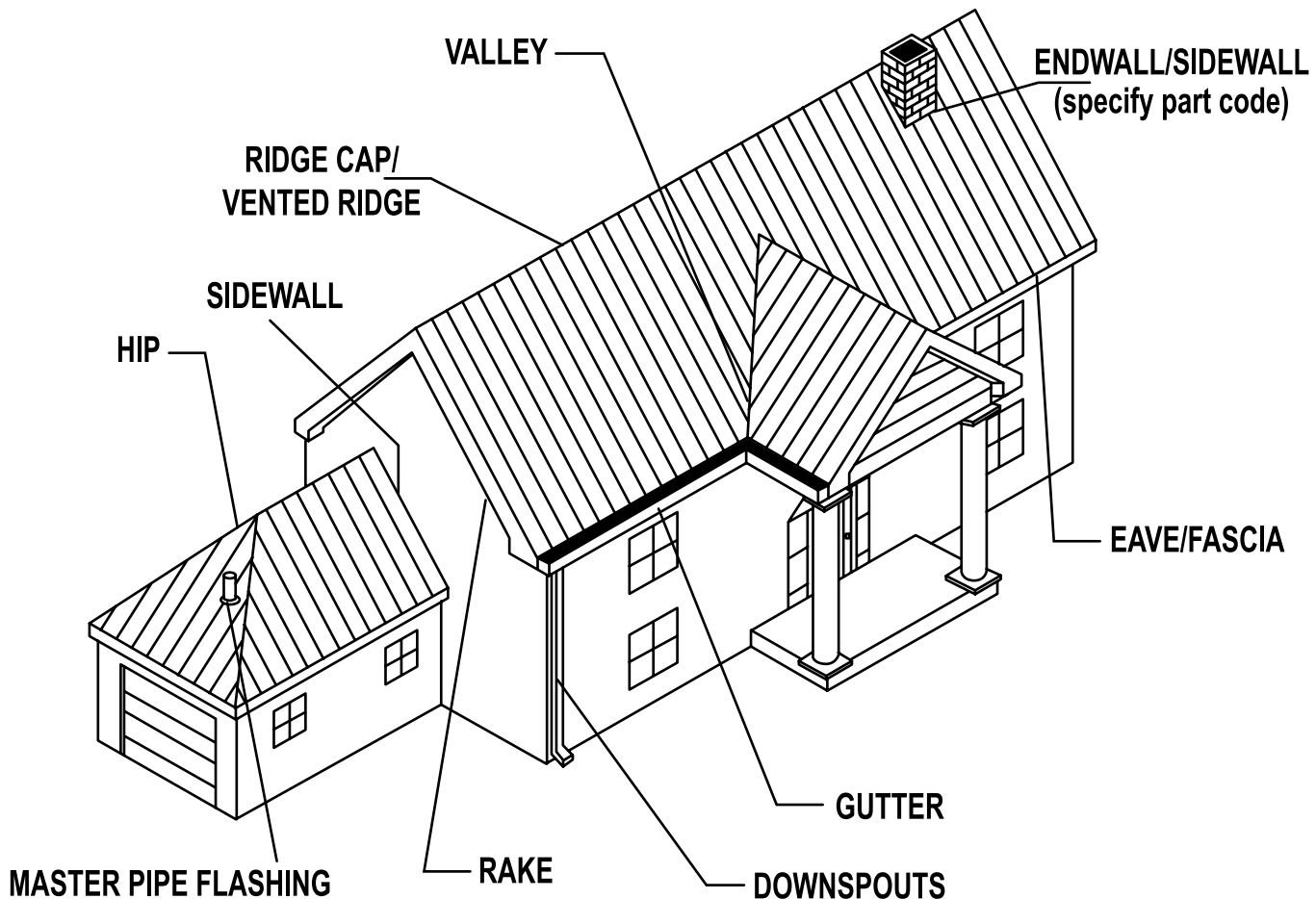

# SOFFIT TRIMS 29 ga. only Part Number Length

F&J ASSEMBLY  
(SFA & JT)

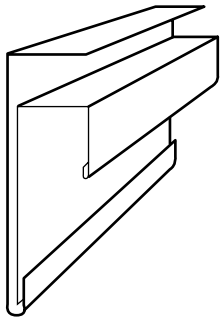

SOFFIT  
F ADAPTOR

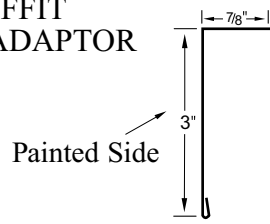

SFA

10'2"

J-TRIM

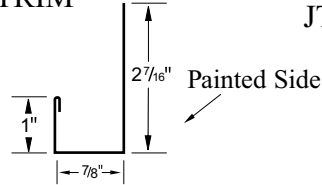

JT(color)

10'2"

SOFFIT J-TRIM

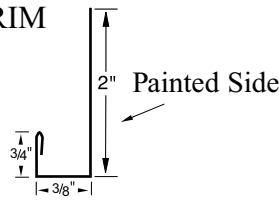

SJT(color)

10'2"

ALUMINUM SOFFIT  
Vented (VS) or Solid (SS)

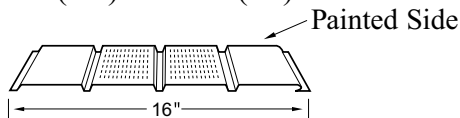

VS(color)12

12'2"

SS(color)12

12'2"

BEADED FASCIA

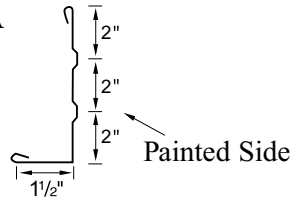

BFT(color)

10'2"

F CHANNEL\*

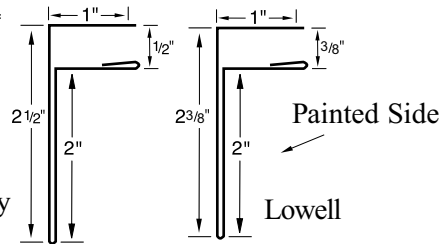

FC(color)

10'2"

Michigan City

Lowell

\*Varies by plant location; please call your salesperson to verify availability.

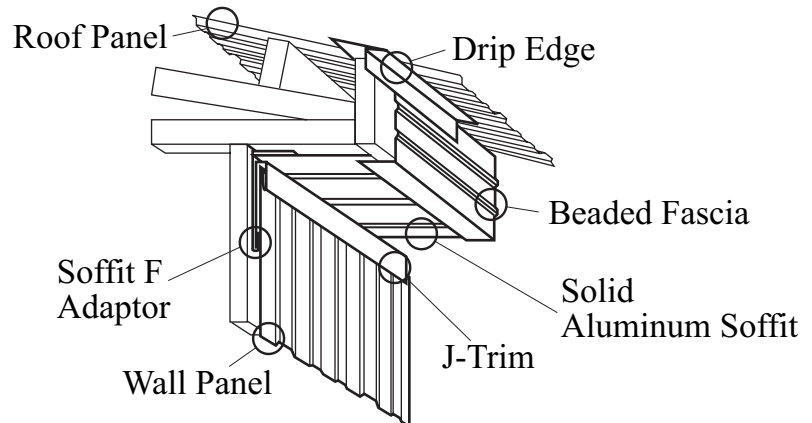
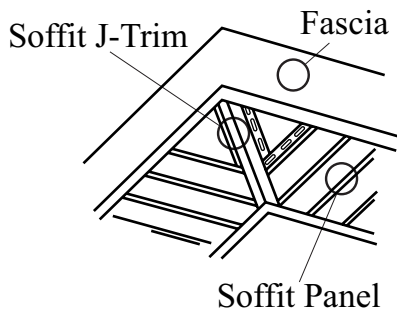



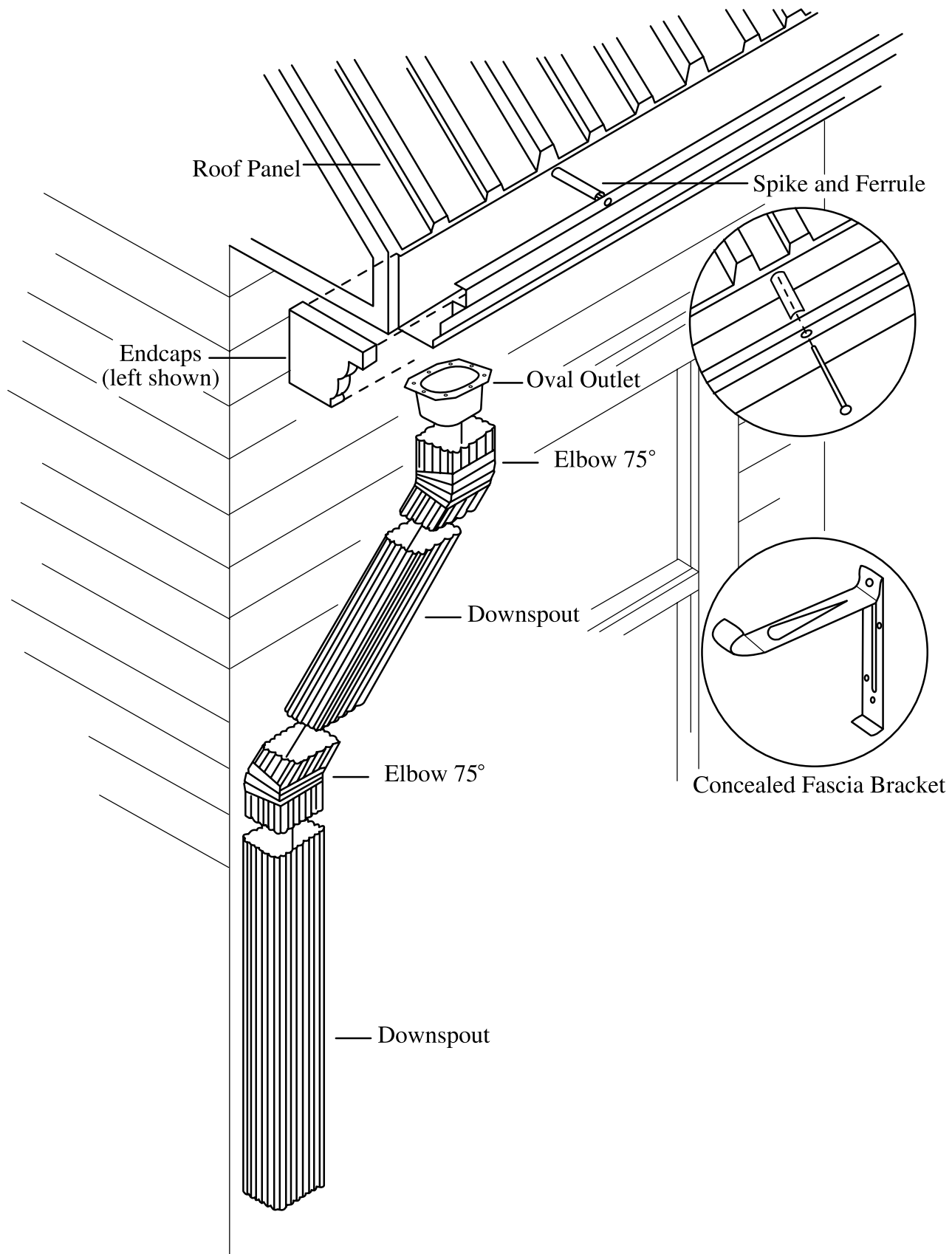



# K5 Gutter

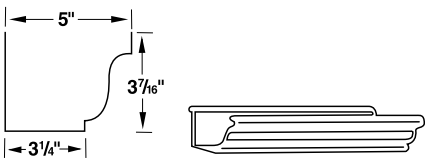
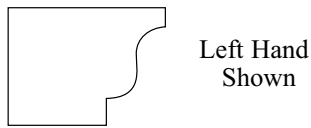

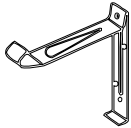
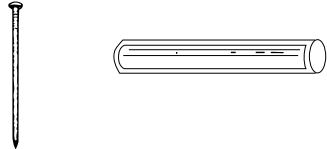
# GUTTERS

Gutter products not available in Gold, Bare Metal, Hawaiian, or Polar.

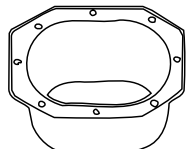
	Part Number	Length
<b>GUTTER</b> 	K5G206(color)	20'6"
<b>GUTTER END CAP</b> 	K5GECR(color) K5GECL(color)	Right hand. Left hand. Specify right or left hand.
<b>CORNER BOXES</b> 	K5GISQCR K5GOSQCR	Inside. Outside. Alamo Only.
<b>CONCEALED FASCIA BRACKET</b> 	K5GCFZ	Qty: 100 per box.
<b>SPIKES &amp; FERRULES</b> 	K5GS8 K5GF5	8" Spike Qty: 50 lbs. per box. 5" Ferrule Qty: 500 per box.
<b>DOWNSPOUT</b> 	K5GDS10(color)	10'0"  Qty. 15 per box.
<b>DOWNSPOUT STRAP</b> 	K5GSCB(color)	Qty: 100 per box.
<b>DOWNSPOUT ELBOW</b> 	K5GEA(color)	Qty: 20 per box.
<b>OVAL OUTLET</b> w/ Flange 	K5GOOFZ	Qty: 50 per box.

# ACCESSORIES

## PROFILE RIDGE VENT

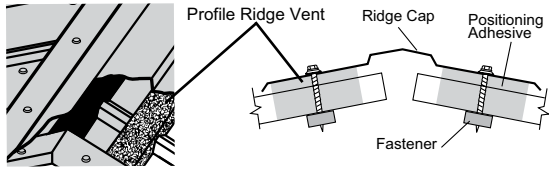

### Part Number

SSRVENT

### Length

Qty: 100' per package  
Horizon-Loc only

PLPVENT

Qty: 100' per package  
Panel-Loc Plus only

## PROFILE RIDGE VENT CLIP

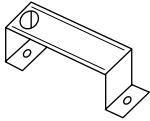

SSRVENTCLIP

Qty: 25 per box  
Use only flat ridgecap with clips.

## CLOSURE VENT



Closure is 1 3/8" tall, may require longer screw for installation.

CLV+ (Panel Loc Plus)

3' Available at Jasper, Cedar Hill and Michigan City

CLV+M (Panel Loc Plus) (Marco)

3' Available at Lowell

Item may vary from sample shown. Contact sales rep for more information

Qty: 50 per box Min. qty = 1 closure vent

## MASTER PIPE FLASHING

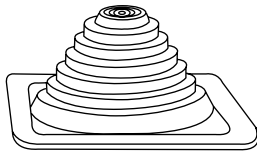

### Part Number

### Size

MPF

1/4" to 4"

MPF2

1 1/4" to 3"

MPF4

3" to 6"

MPF6

5" to 9"

MPF7

6" to 11"

Maximum Temperature  
250 degrees

MPF8

7" to 13"

4SMPF\*

3" to 6"

6SMPF\*

5" to 9"

8SMPF\*

7" to 13"

Maximum Temperature  
500 degrees

10SMPF\*

13" to 26"

## MASTER PIPE FLASHING WITH ZIPPER

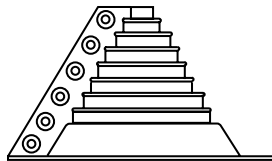

MPF1ZIP\*

1/2" - 4" with zipper

MPF2ZIP\*

4 1/2" - 9" with zipper

\*Not available in all locations. Contact sales rep for lead times.

### Part Number

### Length

### Color

### # per bag

### # per box

## METAL/WOOD SCREWS #10

1/4" head



1(color)MW

1"

All

250

3000pc

1 1/2(color)MW

1 1/2"

All

250

2500pc

2(color)MW

2"

All

250

2000pc

2 1/2(color)MW

2 1/2"

All Except Gold

250

1500pc

3(color)MW

3"

All Except Gold

250

1000pc

Per bag or per box quantity only.  
Minimum quantity 1 bag.

# ACCESSORIES

## STITCH SCREWS

1/4" head

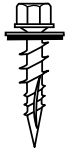

Part Number	Length	Color	# per bag	# per box
34(color)	3/4"	All	250	3000

Per bag or per box quantity only.  
Minimum quantity 1 bag.

## METAL/METAL SCREW#12

5/16" head



34(color)MM	3/4"	All	250	2500
114(color)MM	1 1/4"	All	250	2500
112(color)MM	1 1/2"	Polar, Brilliant, Stone, Bare, Hunter	250	2500

Per bag or per box quantity only.  
Minimum quantity 1 bag.

## LAP SCREWS

5/16" head



78(color)LAP	7/8"	All	250	
--------------	------	-----	-----	--

Per bag or per box quantity only.  
Minimum quantity 1 bag.

## LOW PROFILE PANCAKE HEAD SCREWS

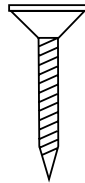

SSR1WOOD	1"		250	5000
----------	----	--	-----	------

Horizon-Loc only

## BUTYL TAPE

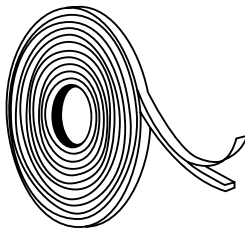

Part Number	Length	Dimensions
BT	40'	1/4" x 3/16"
BTR	40'	7/8" x 3/16"

BT 20 rolls per box  
BTR 10 rolls per box  
Min. qty = 1 roll

## CLOSURES (INSIDE or OUTSIDE)

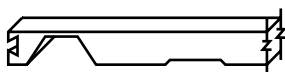
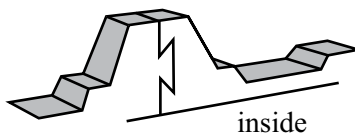

Part Number	Length
CLOUT	Panel Loc outside (no adhesive) 3'
CLOUT+	Panel Loc Plus outside (no adhesive) 3'
CLIN	Panel Loc inside (no adhesive) 3'
CLIN+	Panel Loc Plus inside (no adhesive) 3'
CLOUTWGLUE	Panel Loc outside (with adhesive) 3'
CLOUT+GLUE	Panel Loc Plus outside (with adhesive) 3'
CLINWGLUE	Panel Loc inside (with adhesive) 3'
CLIN+GLUE	Panel Loc Plus inside (with adhesive) 3'

100 per box

Min. qty = 1 closure

# ACCESSORIES

## UNIVERSAL POLYFOAM

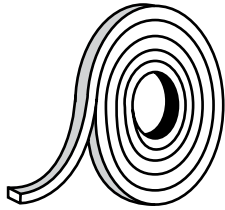

### Part Number

POLY

### Length

25'

### Dimensions

1"x1 1/2"

10 rolls per box.  
No glue/adhesive.

## GRAYFLEX Joint Seal Tape



### Part Number

GRAYFLEX-6

### Length

20'

### Width

1"

### Thickness

1" \*\*

10 rolls per box.  
\*\*Expanded size.

## 16" OUTSIDE CLOSURE WITH GLUE

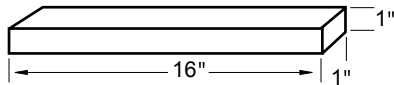

### Part Number

SSRCLOSUGLUEB

### Color

Black foam

Horizon-Loc only

## VERSAVENT Ridge Vent Material



### Part Number

VERSA

### Length

10'

## RETRO-EASE

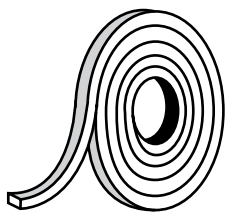

### Part Number

RETROEASE

### Size

300 ft. roll

## TOUCH UP PAINT



### Part Number

4(color)SP

### Size

.6 oz bottle  
with brush

Available in all colors.

4ZZSP

4.5 oz spray paint

Available in backer coat.

## GEOCEL-TRIPOLYMER SEALANT

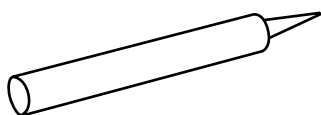

### Part Number

GEO(color)

### Length

10.6 oz. tube

### Color

Clear, gray,  
white

Qty: 24 per box.

Min. qty = 1 tube