

# Central Snap<sup>®</sup> Product Guide

HELPFUL INFORMATION ON PANELS, TRIMS, GUTTERS AND ACCESSORIES

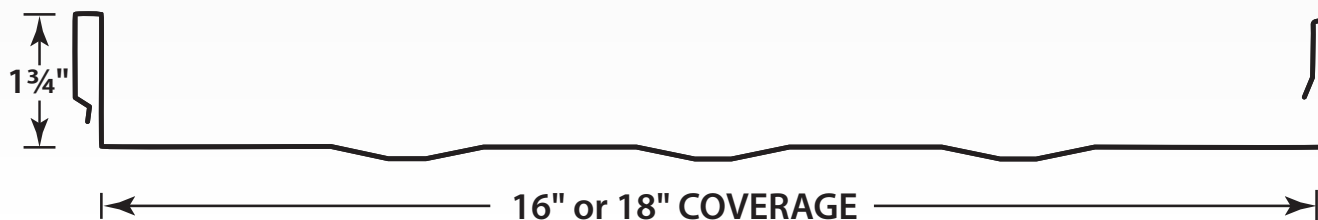
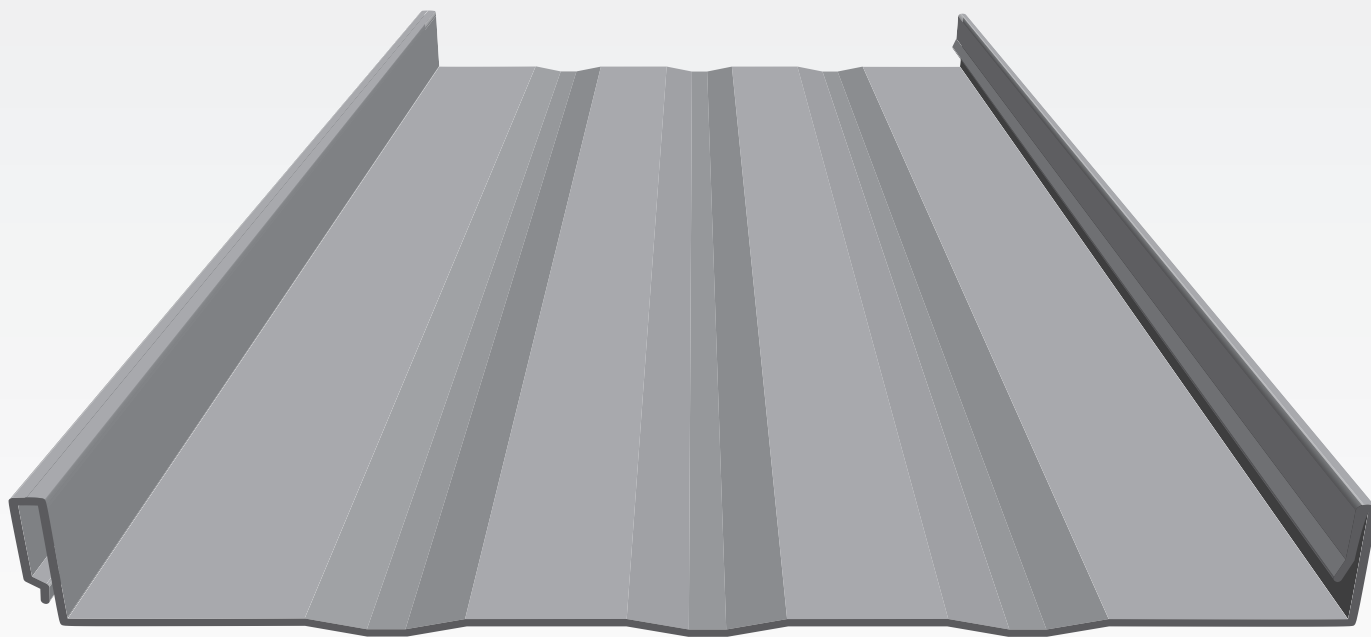

***We promise to improve your business  
by accurately providing quality products  
right when you need them. Every time.***

Visit our website for more product information, testing, energy ratings, warranties, photo gallery, roofing visualizer, and more.

**centralstatesmfg.com**

# INDEX

---

*Information in this catalog may vary by plant location.  
Please call your salesperson to verify product availability.*

Panel Codes	4
Section Properties	5
Receiving and Handling	6-7
Tools/Field Cutting	8
Converting Pitch to Degree	9
Gauge and Color Codes	10
Roof Trims	11-12
Accessories	12-13
Gutters	14

*NOTICE: The application and detail drawings in this manual are strictly for illustration purposes and may not be applicable to all building designs or product installations. Projects should conform to local building codes. Central States Manufacturing is not responsible for the performance of the material if it is not installed correctly.*

*Information contained in this booklet was in effect at the time of publication and is subject to change without notice.*

## WARRANTIES

---



### WARRANTIES

Warranties are available in paper format and downloadable from our website. After the job is complete, fill out a warranty with your contractor/installer details and the Central States order number. Give the warranty to the building owner to keep for their records. Optional warranty registration is available online.

*Learn more at [centralstatesmfg.com/warranties](http://centralstatesmfg.com/warranties)*

# CENTRAL SNAP®

Central Snap® is a performance rated non-structural, architectural standing seam roof system. It has an easy to install 1 3/4" high snap-lock joint making it ideal for architectural and light commercial applications. Central Snap® is available in net coverage widths of 16" or the economical 18". It offers an architecturally pleasing look over metal framing or wood decking.

- 1:12 pitch or greater.
- Snap-together panel, no field seaming required.
- Available in 16" or 18" coverage.
- Minimum length: 3', maximum length: 50'.
- Factory applied sealant insures a secure lap.
- Available with a 1 1/8" notch on either end of the panel for the ease of turning under; reducing installation labor and costs.
- Can be installed over solid substrates or installed over framing depending upon the panel width and support member spans.

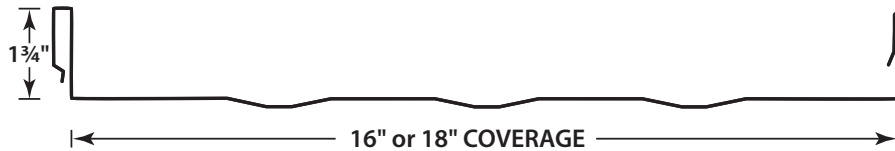

## PANEL CODES

PANEL PROFILE	TYPE	CODE
Central Snap® 16"	Striated	SN164(color)
Central Snap® 16"	Notched	SN164(color)N
Central Snap® 16"	No Striations*	SN164(color)NS
Central Snap® 16"	No Striations, notched*	SN164(color)NSN
Central Snap® 18"	Striated	SN184(color)
Central Snap® 18"	Notched	SN184(color)N
Central Snap® 18"	No Striations*	SN184(color)NS
Central Snap® 18"	No Striations, notched*	SN184(color)NSN

\*NOTE: Striation waver must be signed before producing any order without striations. Panels with no striations may exhibit oil canning in the flat area of the panels. This is common to the industry and does not affect the integrity of the panel and is not a reason for rejection.

# SECTION PROPERTIES

## CENTRAL SNAP® PANEL, 24 GA.

Panel Width (inches)	Thickness (inches)	Weight (psf)	Yield Stress (ksi)	Allowable Shear (kips/ft)	Top in Compression (Positive Bending)			Bottom in Compression (Negative Bending)		
					lxx in4/ft	Sxx in3/ft	Ma in.kips/ft	lxx in4/ft	Sxx in3/ft	Ma in.kips/ft
16	0.0225	1.277	50	1.51	0.0840	0.0565	1.412	0.0398	0.0410	1.026
18	0.0225	1.237	50	1.34	0.0760	0.0505	1.261	0.0353	0.0365	0.913

Section properties and allowables are calculated in accordance with North American Specification for the Design of Cold-Formed Steel Structural Members (2012 & 2016 Edition). I +/- is for deflection determination, S +/- is for bending determination & M8 is allowable bending moment. Ma is allowable bending moment and v. is allowable shear strength of panel web elements. All values are for one foot of panel width. Minimum deliverable bare steel thickness should not be less than 0.95 of design thickness.

# THEORETICAL ALLOWABLE LIVE & WIND LOADS

## ALLOWABLE LIVE LOADS - 24 Gauge Material. All loads in pounds per square foot.

Width (in)	Span Condition		Allowable Live Loads (lb/ft2)										
			Span (ft)										
			2	2.25	2.5	2.75	3	3.25	3.5	3.75	4	4.5	5
16	SS	Stress	235.4	186.0	150.6	124.5	104.6	89.1	76.9	67.0	58.8	46.5	37.7
		L/180	917.8	644.6	469.9	353.0	271.9	213.9	171.2	139.2	114.7	80.6	58.7
	DS	Stress	169.3	134.1	108.7	90.0	75.7	64.5	55.7	48.5	42.6	33.7	27.3
		L/180	2208.9	1551.4	1131.0	849.7	654.5	514.8	412.2	335.1	276.1	193.9	141.4
	TS	Stress	197.1	156.1	126.7	104.9	88.2	75.2	64.9	56.6	49.7	39.3	31.9
		L/180	1731.9	1216.4	886.7	666.2	513.2	403.6	323.2	262.7	216.5	152.0	110.8
18	SS	Stress	210.2	166.1	134.5	111.2	93.4	79.6	68.6	59.8	52.6	41.5	33.6
		L/180	830.4	583.2	425.1	319.4	246.0	193.5	154.9	126.0	103.8	72.9	53.1
	DS	Stress	150.6	119.2	96.7	80.0	67.3	57.4	49.5	43.1	37.9	30.0	24.3
		L/180	1998.5	1403.6	1023.3	768.8	592.2	465.8	372.9	303.2	249.8	175.5	127.9
	TS	Stress	175.3	138.9	112.7	93.3	78.5	66.9	57.7	50.3	44.2	35.0	28.3
		L/180	1567.0	1100.5	802.3	602.8	464.3	365.2	292.4	237.7	195.9	137.6	100.3

## ALLOWABLE WIND UPLIFT LOADS - 24 Gauge Material. All loads in pounds per square foot.

Width (in)	Span Condition		Allowable Live Loads (lb/ft2)										
			Span (ft)										
			2	2.25	2.5	2.75	3	3.25	3.5	3.75	4	4.5	5
16	SS	Stress	171.0	135.1	109.4	90.4	76.0	64.8	55.8	48.6	42.8	33.8	27.4
		L/180	434.3	305.0	222.4	167.1	128.7	101.2	81.0	65.9	54.3	38.1	27.8
	DS	Stress	231.0	183.3	148.8	123.3	103.7	88.5	76.4	66.6	58.6	46.3	37.5
		L/180	1045.3	734.1	535.2	402.1	309.7	243.6	195.0	158.6	130.7	91.8	66.9
	TS	Stress	268.3	213.0	173.1	143.5	120.8	103.1	89.0	77.6	68.3	54.0	43.8
		L/180	819.6	575.6	419.6	315.3	242.8	191.0	152.9	124.3	102.4	72.0	52.5
18	SS	Stress	152.1	120.2	97.4	80.5	67.6	57.6	49.7	43.3	38.0	30.0	24.3
		L/180	386.0	271.1	197.7	148.5	114.4	90.0	72.0	58.6	48.3	33.9	24.7
	DS	Stress	206.3	163.6	132.9	110.1	92.6	79.0	68.2	59.5	52.3	41.4	33.5
		L/180	929.1	652.6	475.7	357.4	275.3	216.5	173.4	141.0	116.1	81.6	59.5
	TS	Stress	239.5	190.2	154.6	128.1	107.9	92.1	79.5	69.3	61.0	48.2	39.1
		L/180	728.5	511.7	373.0	280.2	215.9	169.8	135.9	110.5	91.1	64.0	46.6

Allowable load based on stress is the smallest load due to bending, shear and combined bending and shear. Allowable load based on deflection limit cannot exceed allowable load based on stress. These loads are for panel strength. Allowable loads do not include support/attachment conditions or load testing. Frames, purlins, clips, fasteners and all supports must be designed to resist all loads imposed on the panel. Allowable uplift loads based on stress have not been increased by 33.33 % for wind uplift. Allowable loads for deflection are based on deflection limitation of span/180. For roof panels, self weight of the panel has to be deducted from the allowable inward load to arrive at the actual 'live load' carrying capacity of the panel. SS = Simple span, DS = Double Span and TS = Three or more spans.

# RECEIVING & HANDLING

## MATERIAL INVENTORY

Your material is carefully inspected and crated before leaving the plant and accepted by the transportation company as being complete and in satisfactory condition. It is the carrier's responsibility to deliver the shipment intact. It is the consignee's responsibility to inspect the shipment for damages and shortages when it is delivered.

Conducting a material inventory at the time of delivery is essential. By conducting the materials inventory, the erector is able to identify any material shortage or damage and avoid stopping installation later because of such shortage or damage.

It is imperative that any shortages or damage of the delivered materials be noted at once and clearly marked on the bill of lading before signature of acceptance. Notify Central States immediately of any conflicts. Central States will not be responsible for shortages or damages unless they are noted on the bill of lading.

In the case of packaged components (such as clips, fasteners and sealants, etc.), the quantities are marked on their container and should be checked against the bill of materials. Central States must be notified of any shortages or concealed damage within 15 days of delivery.

## EQUIPMENT FOR UNLOADING AND LIFTING

Hoisting equipment is necessary to unload and position the panels and accessory crates for site storage and installation. The equipment must have sufficient capacity and reach to place the material where it is required for efficient installation.

Slings will be required to minimize panel damage. The recommended slings are nylon straps of 6" minimum

width and of sufficient length to accommodate the panel bundle girth.

A spreader bar will be required for the longer panel crates to assure correct sling spacing and uniform lifting. The spreader bar must be large enough to handle the maximum panel bundle weight and length.

A forklift is handy for unloading and placing shorter panel and accessory crates.

## LIFTING ROOF PANEL BUNDLES

Under normal conditions, panel crates less than 35' long can be lifted with two slings spaced at third points. Panel crates longer than 35' can be lifted with three slings located at quarter points using a spreader bar to achieve correct sling spacing for uniform lift.

Slings should be located under the cross boards. Loads should always be checked for secure hook-up, proper

balance, and lift clearance. Tag lines should be used if necessary to control the load during lifting, especially if operating in the wind.

Panel crates less than 25' long may be lifted with a forklift only if the forks are spread at least 5' apart and blocking is used to prevent panel damage by the forks.

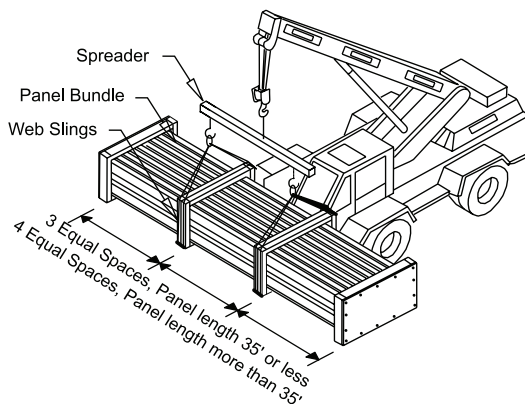

Panels over 25'

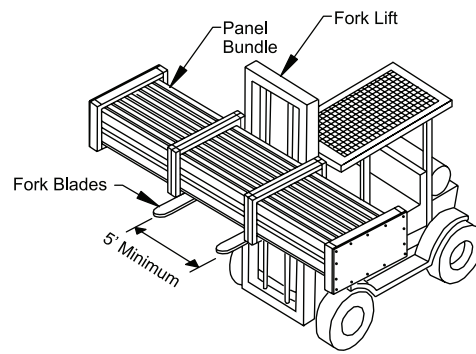

\*For illustration only. Actual packaging may differ from drawing.

# RECEIVING & HANDLING

## FIELD STORAGE

Upon acceptance of the shipment, the customer or his representative is responsible for proper handling storage and security of the roof materials. Central-States is not liable for damage or loss of materials at the job site.

The roof panel bundles should be stored on the job site in accordance with the following recommendations:

- A. Store panels in a protected area, out of standing water and drifting snow, etc.
- B. Elevate panels with blocking to allow air circulation under the bundle.
- C. Slope panels for drainage of moisture from the panels.
- D. As necessary, cover panels with waterproof tarp, allowing for air circulation (do not wrap tarp under panel crate or restrict air movement).
- E. Inspect panels daily for moisture accumulation.
- F. If panel bundles contain moisture, the panels should be dried and re-stacked. Use care in re-stacking to avoid damage to panels.
- G. Opened or re-stacked panel bundles should be secured to prevent wind damage.

When moving panel bundles, extreme caution should be taken to prevent damage to the panel edges. Uncrated panels should be supported at each end and at 10' spaces.

All bundles or loose panels on the roof should be banded to the roof structurals at the end of each workday. On steep roofs, provisions should be taken to prevent panels and panel crates from sliding off the roof. Be sure to set panel bundles on the roof in the proper direction for the installation sequence.

Trim and accessories should be stored in a secure area and protected from damage, weather, and theft. Fasteners, sealants, closures, etc., should be stored out of the weather and protected from contamination.

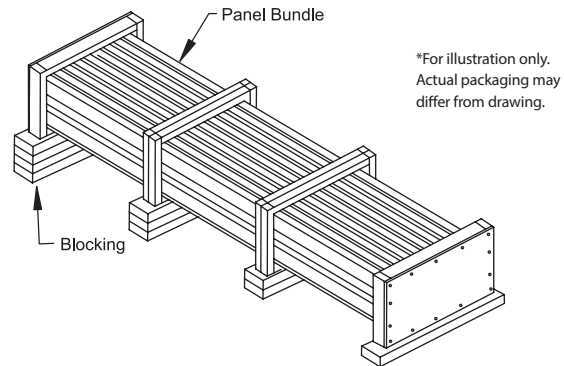

Stack blocking so bundle is sloped for drainage.



## HANDLING INDIVIDUAL ROOF PANELS

To lift individual panels, lift one side of the panel by the seam letting it hang naturally to prevent buckling. Pick-up points should not be more than 10' apart.

**Do not pick-up panels by the ends only, or in a flat position.**

If the individual panels are to be lifted to the roof by hand line, the common method is to use the vice grip "C" clamps. Position the clamps on the flat of the panel as close as possible to one edge so the panel is lifted in a vertical position. The jaws of the vice grips must be padded to prevent damage to the panel surface. The clamps should be uniformly spaced, no more than 10' apart and the hand lines must be pulled in unison so that uneven lifting does not buckle the panel. Be sure the clamps are tight on the panel and the line is secure to prevent dropping the panel which can result in personal injury and property damage.

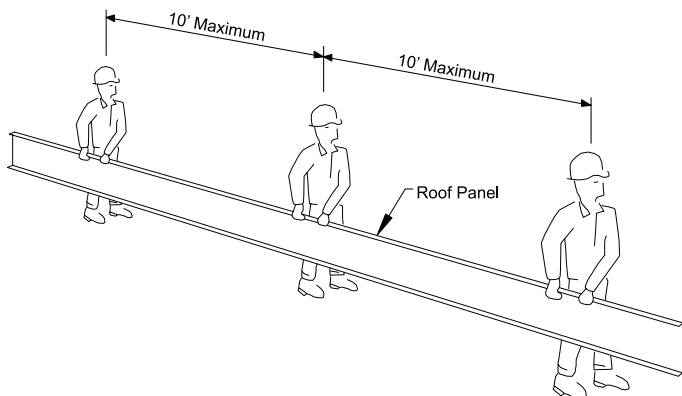

# TOOLS & EQUIPMENT

---

- Snips
- Tape Measure
- Electric Metal Shear\*
- Caulking Gun
- Cordless Drill
- Sockets
- Blind Rivet Tool
- Chalk Line
- 6" Hand Seamer
- Hemming Tool
- Gloves
- Notcher

\*We do not recommend the use of a power circular saw to cut panels. Use of a power saw could:

- Increase the instance of edge rust.
- Cause hot metal shavings on panel surface to damage panel finish.

We recommend that the installer have prior experience and knowledge of the listed tools and their uses in working with metal roofing.

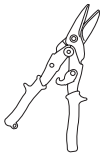

Hand Snips

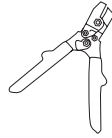

Notchers

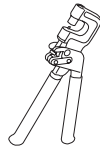

Rivet Hole  
Punch

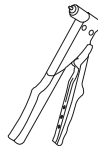

Hand Riveter

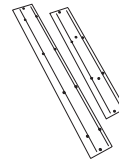

Folding  
Tools



6" Hand  
Seamer

## FIELD CUTTING

---

Central States recommends tin snips/hand shears, electric nibblers or a profile shear to cut metal panels and trim. All product surfaces should be free of debris at all times. Installed surfaces should be wiped clean at the end of each work period. Never cut panels over metal surfaces. When cutting metal panels, always wear heavy gloves to avoid cuts from sharp edges and safety glasses to prevent eye injury.

Central States discourages the use of a power saw that may generate hot metal shavings. Hot shavings can stick to the painted surface. If loose shavings are

not removed from the panel surface immediately they will begin to corrode and shorten the life of the product. One method of preventing this problem is to flip the panel over when cutting and only cut one panel at a time. This allows you to brush shavings off of the back of the panel and helps to avoid damaging the painted finish. Make sure that stacks of panels are away from the cutting area so shavings do not blow onto other panels.



**Shavings created by saw cutting may cause the panel to rust and could result in product failure that is not covered by manufacturers warranty.**



# CONVERTING PITCH TO DEGREE

Use these charts to calculate degrees when designing custom trim.  
Please specify pitch when ordering.

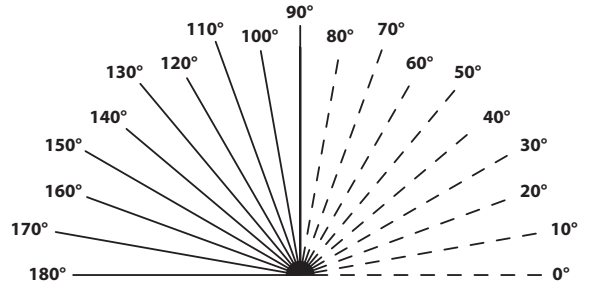

## SINGLE SLOPE PITCHES

Fascia, Eave, Endwall, Tie-In, Gutter

## DOUBLE SLOPE PITCHES

Hip, Valley

## RIDGE CAP

	1:12 PITCH	2:12 PITCH	3:12 PITCH	4:12 PITCH	5:12 PITCH	6:12 PITCH	7:12 PITCH	8:12 PITCH	9:12 PITCH	10:12 PITCH	11:12 PITCH	12:12 PITCH
<b>SINGLE SLOPE PITCHES</b>	94°	99°	104°	108°	112°	116°	120°	123°	126°	129°	132°	135°
<b>DOUBLE SLOPE PITCHES</b>	173°	167°	160°	154°	148°	143°	138°	134°	130°	126°	123°	120°
<b>RIDGE CAP</b>	170°	161°	152°	143°	135°	127°	120°	113°	106°	100°	95°	90°

## TRANSITION TRIM

Find the box that intersects your lower and upper roof pitches.

If the intersection lands in the gray area, select a Lower Transition trim.

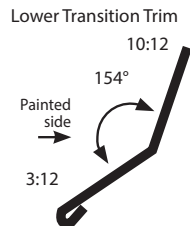
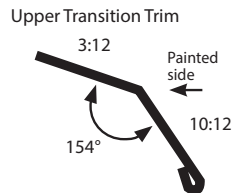

## LOWER ROOF PITCH (INCHES OF RISE OVER 12" OF RUN)

	1:12 PITCH	2:12 PITCH	3:12 PITCH	4:12 PITCH	5:12 PITCH	6:12 PITCH	7:12 PITCH	8:12 PITCH	9:12 PITCH	10:12 PITCH	11:12 PITCH	12:12 PITCH	13:12 PITCH	14:12 PITCH	15:12 PITCH	16:12 PITCH	17:12 PITCH	18:12 PITCH
<b>1:12 PITCH</b>		175°	171°	166°	162°	158°	155°	151°	148°	145°	142°	140°	137°	135°	133°	132°	130°	128°
<b>2:12 PITCH</b>	175°		175°	171°	167°	163°	159°	156°	153°	150°	147°	144°	142°	140°	138°	136°	135°	133°
<b>3:12 PITCH</b>	171°	175°		176°	171°	167°	164°	160°	157°	154°	152°	149°	147°	145°	143°	141°	139°	138°
<b>4:12 PITCH</b>	166°	171°	176°		176°	172°	168°	165°	162°	159°	156°	153°	151°	149°	147°	145°	144°	142°
<b>5:12 PITCH</b>	162°	167°	171°	176°		176°	172°	169°	166°	163°	160°	158°	155°	153°	151°	149°	148°	146°
<b>6:12 PITCH</b>	158°	163°	167°	172°	176°		176°	173°	170°	167°	164°	162°	159°	157°	155°	153°	152°	150°
<b>7:12 PITCH</b>	155°	159°	164°	168°	172°	176°		177°	173°	170°	168°	165°	163°	161°	159°	157°	155°	154°
<b>8:12 PITCH</b>	151°	156°	160°	165°	169°	173°	177°		177°	174°	171°	169°	166°	164°	162°	161°	159°	157°
<b>9:12 PITCH</b>	148°	153°	157°	162°	166°	170°	173°	177°		177°	174°	172°	170°	167°	166°	164°	162°	161°
<b>10:12 PITCH</b>	145°	150°	154°	159°	163°	167°	170°	174°	177°		177°	175°	173°	170°	168°	167°	165°	163°
<b>11:12 PITCH</b>	142°	147°	152°	156°	160°	164°	168°	171°	174°	177°		178°	175°	173°	171°	169°	168°	166°
<b>12:12 PITCH</b>	140°	144°	149°	153°	158°	162°	165°	169°	172°	175°	178°		178°	176°	174°	172°	170°	169°

# HOW TO ORDER TRIM

## STEP 1:

In CentralLink™, start by entering the Item ID.

Item ID is made of the **TRIM CODE**, a **GAUGE CODE**, and a **COLOR CODE**.

The TRIM CODE can be found with each drawing next to the trim's name.

The GAUGE CODE and COLOR CODES are found below.

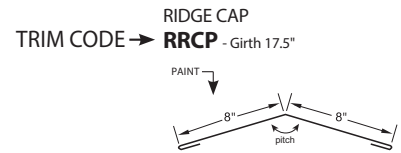

**EXAMPLE:** Ridge Cap, 24 gauge, Autumn

**RRCP**    **4**    **AU**  
TRIM CODE    GAUGE CODE    COLOR CODE

CentralLink order screen

## STEP 2:

Then type the number of pieces you need along with the length in feet and inches.

## GAUGE CODES

GAUGE	CODE
24	4

## COLOR CODES

FLUROPON®	PANEL GAUGE	TRIM GAUGE	CODE
Ash	24	24	AS
Autumn	24	24	AU
Brite	24	24	BT
Bronze	24	24	BZ
Dark Bronze	24	24	DB
Evergreen	24	24	EV
Galvalume®	24	24	GL
Sand	24	24	SA
Slate Gray	24	24	SG
Smoke	24	24	SM
Terratone	24	24	TE
Tudor	24	24	TU
Verdigris	24	24	VE

Galvalume® is a registered trademark of BIEC International, Inc..

# ROOF TRIMS

Unless otherwise noted, trims are 24 gauge, and all angles are 90° or 45°. See page 10 for gauge and color codes.

## RIDGE CAP - Specify pitch.

### RIDGE CAP

**RRCP** - Girth 17.5"

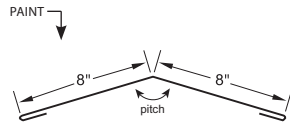

### VENTED RIDGE CAP

**SNVRCP** - Girth 22.5"

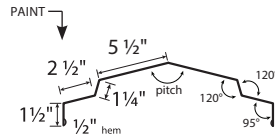

### FLOATING RIDGE CAP

**SNRCP** - Girth 14"

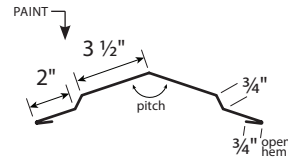

## GABLE/EAVE - Specify pitch.

### EAVE

**SNRDC** - Girth 10.5"

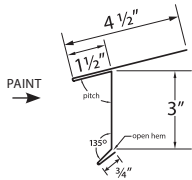

### ALTERNATE EAVE

**SNEA** - Girth 10.375"

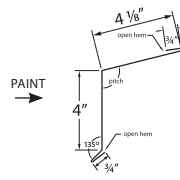

### ALTERNATE HIGH EAVE

**SNGA4** - Girth 11"

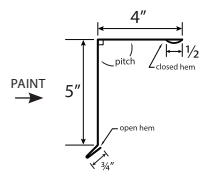

### TRIM CLEAT

**SNTC** - Girth 6.75"

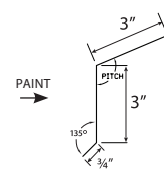

### HIGH EAVE/GABLE

**SNGA5** - Girth 12.25"

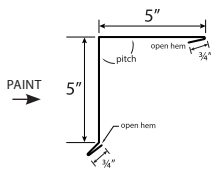

### ALT. GABLE

**SNGA2** - Girth 9.25"

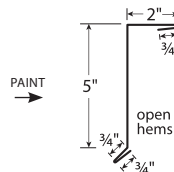

### GABLE TRIM ANGLE

**SPGTA** - Girth 3.5"

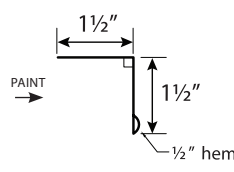

### CONTINUOUS CLEAT

**SSCC** - Girth 3"

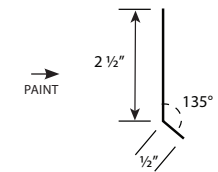

## TRANSITION TRIMS - Specify pitch.

### TRANSITION

**SNTR** - Girth 17.625"

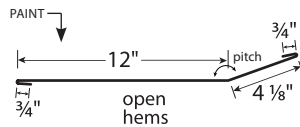

### ENDWALL

**SSEF4** - Girth 13.5"

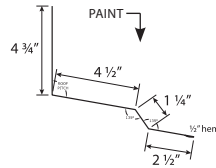

### ENDWALL

**SNEW** - Girth 14.75"

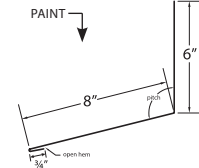

### COUNTERFLASH

**SSCF** - Girth 4.5"

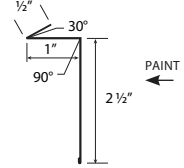

Specify pitch.

### PARAPET RAKE FLASHING

**SSSF3** - Dim. "A" 3" - Girth 8"

**SSSF5** - Dim. "A" 5" - Girth 10"

**SSSF7** - Dim. "A" 7" - Girth 12"

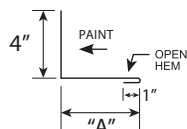

### ALT. PARAPET RAKE FLASHING

**SNRW** - Girth 7"



# ROOF TRIMS

Unless otherwise noted, trims are 24 gauge, and all angles are 90° or 45°. See page 10 for gauge and color codes.

## VALLEY - Specify pitch.

VALLEY

**SNVAL** - Girth 27.5"

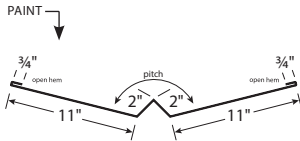

ROOF CLEAT

**SNRCL** - Girth 3.25"

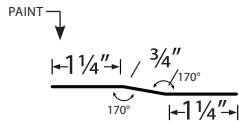

## MISC. TRIMS

ZEE CLOSURE

**SNZEE** - Girth 3.75"

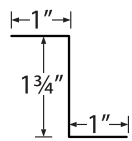

OPTIONAL J-CLOSURE

**SNJC** - Girth 8"

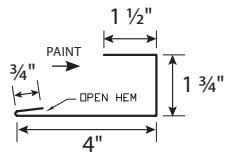

FLAT SHEET

**FS4** - 24 gauge. Girth 48.5"



10 sheets or fewer will be packaged in a roll.  
Additional pallet charge on orders of 10 or more.

## ACCESSORIES

BUTYL TAPE

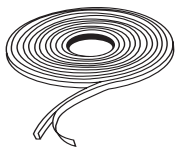

PART #	LENGTH	WIDTH	THICKNESS	ROLLS PER BOX
<b>BTL</b>	45'	3/4"	3/32"	24
<b>BTR</b>	40'	7/8"	3/16"	10
<b>BT3/8</b>	45'	3/8"	3/32"	40

Install between fastener and exposed edge.  
Rolls per box may vary by location and vendor. Check with your sales person for details.

TAPE SEALER

**CL504A** - Tri-Bead, 8 rolls/carton



Length - 25' Width - 7/8" Thickness - 3/16"  
Use to fill any voids at the minor ribs of panel  
for eave and valley conditions.

SEALANT



PART #	SIZE	COLOR
<b>GEO(color)</b>	10.3 oz. tube	clear, gray, white
<b>MRS10(color)</b>	10.3 oz. tube	call for colors
<b>MRS10CLEAR</b>	10.3 oz. tube	clear

TOUCH UP PEN

**PEN(color)** - 0.6 oz. paint pen.



PROFILE RIDGE VENT

**SNVENT16** - 16" Profile. Net free area 48.3 sq.in/ft.

**SNVENT18** - 18" Profile. Net free area 48.3 sq.in/ft.

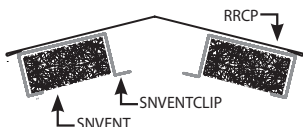

Length - 100' Width - 3". Thickness - 2.125"

CLIP

**SNVENTCLIP** - 25 per box.

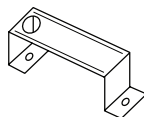

Use with SNVENT. Use lap screw to fasten.

PREVENT

**PREVENT** - 8' section.

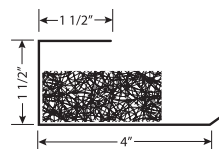

# ACCESSORIES

## RAKE SUPPORT & CLIP

RAKE SUPPORT  
**CL4680** - Length 20'

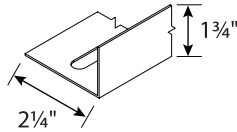

14 gauge red iron.

RAKE CLIP  
**SNCLP** - Fixed clip

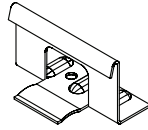

## MASTER PIPE FLASHING - Install in a diamond shape and not parallel to the seam.

Square - Max temperature 250°.

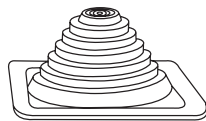

- MPF** - Pipe size .25" to 5.75"
- MPF2** - Pipe size .875" to 4"
- MPF4** - Pipe size 2.75" to 7"
- MPF5** - Pipe size 4" to 7"
- MPF6** - Pipe size 4.75" to 10"
- MPF7** - Pipe size 5.5" to 11.5"
- MPF8** - Pipe size 6.75" to 13.5"
- MPF9** - Pipe size 9.5" to 20.5"

Square - High temp max 500°.

- 3SMPF** - Pipe size .25" to 4"
- 4SMPF** - Pipe size 2.75" to 7"
- 6SMPF** - Pipe size 4.75" to 10"
- 8SMPF** - Pipe size 6.75" to 13.5"
- 10SMPF** - Pipe size 12" to 28.5"

Square with zipper - Max temperature 250°.



- MPF1ZIP** - Pipe size .5" - 4"
- MPF2ZIP** - Pipe size 4" - 9.25"

## TOOLS

FOLDING TOOLS

- 18 FOLD** - 18"
- 24 FOLD** - 24"
- 18 FOLDWHANDLE** - 18" with handle.
- 24 FOLDWHANDLE** - 24" with handle.

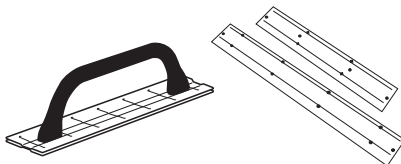

HAND NOTCHER  
**NOTCHER**

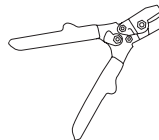

HAND SEAMER  
**SEAMER** - 6"

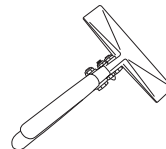

RIVET HOLE PUNCH  
**PUNCH**



RIVET GUN  
**RIVET GUN**

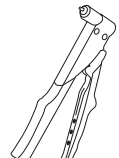

## FASTENERS

Fastener color availability may vary by location, contact your sales consultant for details. Order fasteners in increments of 250 pieces.

TYPE	PART #	LENGTH	DIAMETER	HEAD	COLOR	#BAG
METAL/METAL	<b>114(color)ZACMM</b>	1 1/4"	#12	5/16" HEX	ALL	250
METAL/METAL LAP	<b>78(color)ZACLAP</b>	7/8"	#14	5/16" HEX	ALL	250
PANCAKE HEAD DRILLER	<b>12FASTENER</b>	1"	#10	2/2 QUADREX	GALVANIZED	250
METAL/WOOD CLIP	<b>112SNWFAST</b>	1 1/2"	#10	#2 SQUARE DRIVE	GALVANIZED	250
<i>Pancake head fastener for panel clip &amp; eave plate attachment to wood decking.</i>						
POP RIVET	<b>POP(color)</b>		1/8"		ALL	100

# GUTTERS

**BOX GUTTER**  
**SNGU** - Girth 24.25"

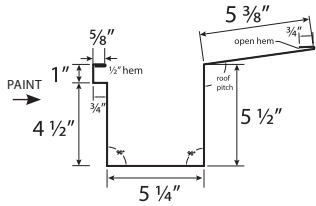

Specify pitch.

**GUTTER EAVE TRIM**  
**SNGET** - Girth 7.5"

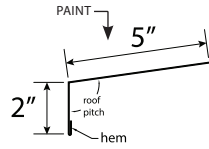

Specify pitch.

## DOWNSPOUTS

**DOWNSPOUT W/O KICKOUT**  
**DS** - Girth 16"

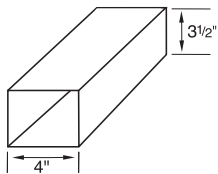

**DOWNSPOUT WITH KICKOUT**  
**DK**

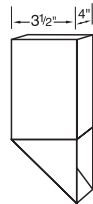

**DOWNSPOUT OUTLET**  
**DSOUTLET**

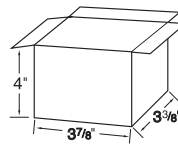

Specify pitch. 1/2" turndowns.

**DOWNSPOUT CONNECTOR**  
**DSLVE**

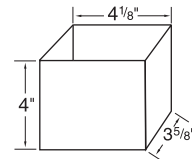

**DOWNSPOUT ELBOW**  
**DSE45**  
**DSE90**

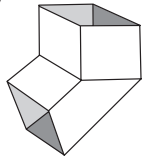

**DOWNSPOUT STRAP**  
**DSS**

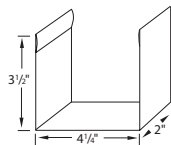

**GUTTER STRAP**  
**SNGS** - 3.125" wide.

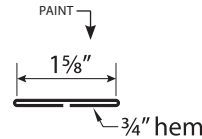

Field cut to length.

**GUTTER END CAP** - Specify pitch.  
**SNBGEN** - For box gutters.

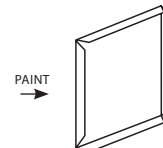





Right.  
On Time.  
Every Time.

[centralstatesmfg.com](http://centralstatesmfg.com)